



PR-AC

Aspiratori centrifughi in materiale plastico Centrifugal fans in plastic material



A RICHIESTA UPON REQUEST

- Versione con cassa realizzata in PP, polipropilene (PR-AC/PP).
- Versione con cassa realizzata in PER, polietilene antistatico e autoestinguente (PR-AC/PER).
- Versione con sedia in acciaio inossidabile AISI 304.
- Version with casing in PP, Polypropylene (PR-AC/PP).
- Version with casing in PER, anti-static and self-extinguishing polyethylene (PR-AC/PER).
- Version with motor support in stainless steel AISI304.

DESCRIZIONE

La serie PR-AC è particolarmente adatta a convogliare fumi e vapori corrosivi (non abrasivi) o ad alto tasso di umidità con temperatura del fluido da -15°C a +70°C.

Il PR-AC è un ventilatore centrifugo a pale rovesce in materiale plastico con caratteristiche tecniche e meccaniche che permettono una durata nel tempo. La girante a pale rovesce conferisce a questa serie buone caratteristiche di silenziosità ed efficienza aeraulica.

Il PR-AC, quando ha terminato il suo ciclo vitale, è facilmente smaltibile, grazie ai materiali riciclabili con cui è costruito.

COSTRUZIONE

- Cassa a spirale realizzata in polietilene (PE).
- Girante a semplice aspirazione, realizzata in polipropilene (PP), con pale rovesce e mozzo in alluminio protetto dal fluido trasportato.
- Sedia portamotore realizzata in lamiera d'acciaio e verniciata a polveri epossipoliestiriche.

MOTORIZZAZIONI

- Motore asincrono trifase o monofase a norme internazionali IEC 60034, IEC 60072, EMC 2014/30/UE, LVD 2014/35/UE e marcato CE IP55, classe F, forma B3 o B5. Idoneo ad un servizio S1 (funzionamento continuo a carico costante).

ACCESSORI

- Rete di protezione per bocca aspirante e premente realizzata a norma UNI 10615.
- Giunto antivibrante in PVC per bocca aspirante e premente.
- Serranda a gravità.
- Serranda di taratura manuale.

DESCRIPTION

The PR-AC series is particularly designed for conveying smoke and corrosive vapours and smokes, also with high humidity level and with fluid temperature range from -15°C to +70°C.

The PR-AC is a centrifugal backward curved fan with technical and mechanical characteristics that grant a long lasting operation. The backward curved impeller provide good characteristics of low noise and high efficiency.

The PR-AC fan, when its lifetime is finished, is easy to dispose, being manufactured with recyclable materials.

CONSTRUCTION

- Volute in polyethylene (PE).
- Single inlet impeller, in Polypropylene (PP), with backward curved blades and aluminium hub (protected from the fluid).
- Motor support in epoxy painted steel sheet.

MOTOR

- Asynchronous three-phase or single-phase motors according to international standards IEC 60034, IEC 60072, EMC 2014/30/UE, LVD 2014/35/UE, CE marked, IP 55, class F, B3 or B5 shape. Suitable to a S1 service (continuous working to constant load).

ACCESSORIES

- Inlet and outlet protection guard according to UNI 10615.
- Anti-vibration joint in PVC for inlet and outlet sides.
- Gravity shutter.
- Manual setting shutter.

VERSIONI | VERSIONS



PR-AC ATEX

Versione antideflagrante secondo la Direttiva 2014/34/UE
Explosion-proof version according to Directive 2014/34/UE

PRESTAZIONI | PERFORMANCE

PR-AC

Le prestazioni aerauliche sono rilevate in conformità alla norma EN ISO 5801/AMCA 210 con densità dell'aria standard avente peso specifico 1,2 Kg/m³. Alimentazione 230V/1Ph/50Hz o 400V/3Ph/50Hz. Air performances measured according to EN ISO 5801 / AMCA 210 standard with air density with 1,2 Kg/m³ specific weight. Power supply 230V/1Ph/50Hz or 400V/3Ph/50Hz.

Lp Livello di pressione sonora rilevato in condizioni di campo libero, propagazione sferica, categoria di misura C a norma EN ISO 13349, nel punto di massimo rendimento, alla distanza di 1,5 metri dal lato aspirazione e si presenta solo per fini comparativi. Sound pressure level measured in free field conditions, propagation spherical, measurement category C in accordance with EN ISO 13349, at the point of maximum efficiency at a distance of 1,5 meters, inlet side (for comparative purposes only).

Lw Livello di potenza sonora ottenuto secondo norma ISO 3746. Tolleranza +/- 3 dB(A). Sound power level obtained in accordance with EN ISO 3746. Tolerance +/- 3 dB(A).

PR-AC 200

Code	Tipo Type	Modello Model	U	P	Pm (kW)	In (A)	IP/CL	IE3	Mot. (Gr)
7PA2104	PR-AC	202	M	2	0,18	1,40	55/F	-	63
7PA2105		202	T	2	0,18	0,55	55/F	-	63

LIVELLI SONORI | SOUND LEVELS dB(A)

Hz		63	125	250	500	1000	2000	4000	8000	TOT
202	Lw	51,1	63,2	68,7	75,1	74,3	70,5	62,3	52,2	79
	Lp	37	49	54	61	60	56	48	38	65

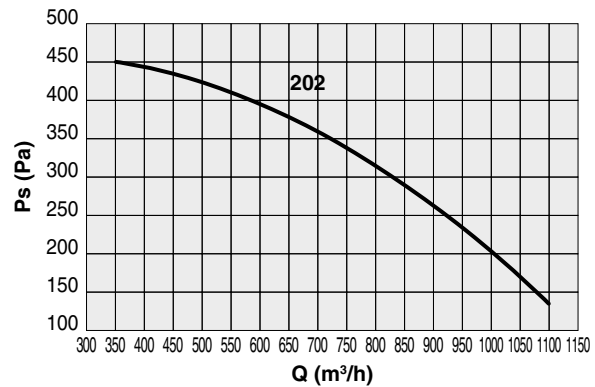

PR-AC 250

Code	Tipo Type	Modello Model	U	P	Pm (kW)	In (A)	IP/CL	IE3	Mot. (Gr)
7PA2628	PR-AC	252	M	2	0,37	2,50	55/F	-	71
7PA2630		252	T	2	0,37	1,00	55/F	-	71
7PA2629		254	M	4	0,12	1,10	55/F	-	63
7PA2631		254	T	4	0,12	0,45	55/F	-	63

LIVELLI SONORI | SOUND LEVELS dB(A)

Hz		63	125	250	500	1000	2000	4000	8000	TOT
252	Lw	58	70,1	75,6	82	81,2	77,4	69,2	59,1	86
	Lp	43	56	61	67	67	63	55	45	72
254	Lw	43,1	55,2	63,7	64,1	66,3	62,5	54,3	44,2	71
	Lp	29	41	49	50	52	48	40	30	56

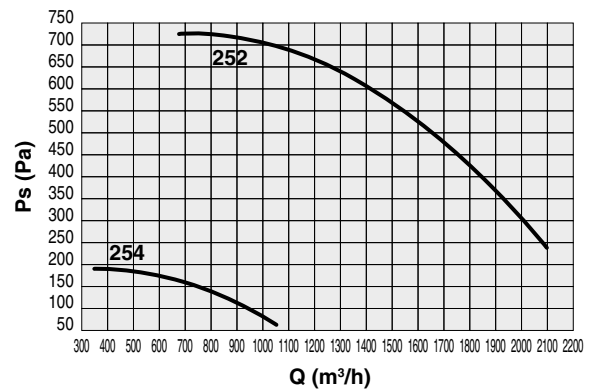

PR-AC 280

Code	Tipo Type	Modello Model	U	P	Pm (kW)	In (A)	IP/CL	IE3	Mot. (Gr)
7PA2807	PR-AC	282	M	2	0,75	4,60	55/F	-	80
7PA2892		282	T	2	0,75	1,75	55/F	✓	80
7PA2808		284	M	4	0,18	1,60	55/F	-	63
7PA2893		284	T	4	0,18	0,65	55/F	-	63

LIVELLI SONORI | SOUND LEVELS dB(A)

Hz		63	125	250	500	1000	2000	4000	8000	TOT
282	Lw	61,8	73,9	79,4	85,8	85	81,2	73	62,9	90
	Lp	47	59	65	71	70	67	58	48	75
284	Lw	46,8	58,9	67,4	67,8	70	66,2	58	47,9	74
	Lp	32	44	53	53	55	52	43	33	60

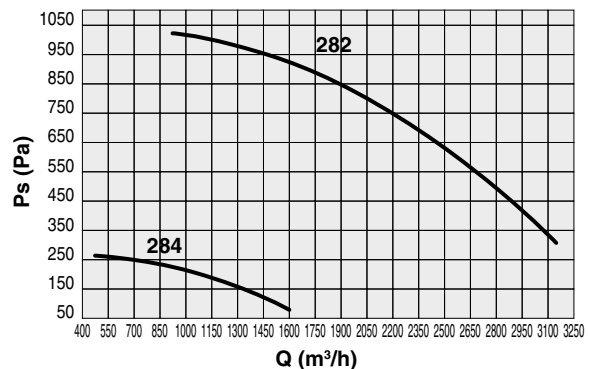

sez. 1.9

PR-AC aspiratori | fans

PR-AC 310

Code	Tipo Type	Modello Model	U	P	Pm (kW)	In (A)	IP/CL	IE3	Mot. (Gr)
7PA3225	PR-AC	312	M	2	1,50	9,10	55/F	-	90S
7PA3227		312	T	2	1,50	3,00	55/F	✓	90S
7PA3226		314	M	4	0,25	1,90	55/F	-	71
7PA3228		314	T	4	0,25	0,85	55/F	-	71
7PA3229		316	T	6	2,20	4,30	55/F	✓	71

LIVELLI SONORI | SOUND LEVELS dB(A)

Hz		63	125	250	500	1000	2000	4000	8000	TOT
312	Lw	64,5	76,6	82,1	88,5	87,7	83,9	75,7	65,6	93
	Lp	50	62	68	74	73	69	61	51	78
314	Lw	49,5	61,6	70,1	70,5	72,7	68,9	60,7	50,6	77
	Lp	35	47	56	56	58	54	46	36	63
316	Lw	39	54,1	56,6	60	62,2	58,4	50,2	40,1	66
	Lp	24	40	42	45	48	44	36	26	52

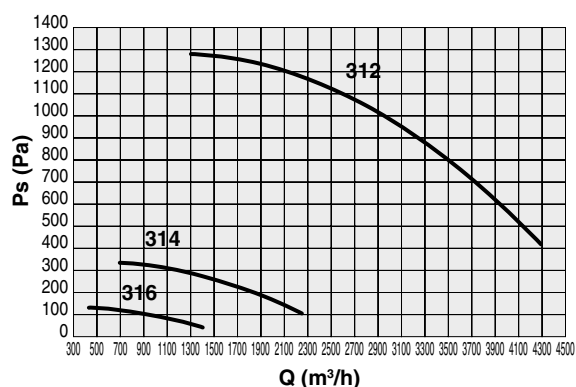

PR-AC 350

Code	Tipo Type	Modello Model	U	P	Pm (kW)	In (A)	IP/CL	IE3	Mot. (Gr)
7PA3507	PR-AC	352	T	2	2,20	4,30	55/F	-	90L
7PA3628		354	M	4	0,18	0,75	55/F	-	71
7PA3508		354	T	4	0,18	0,75	55/F	-	71
7PA3509		356	T	6	0,55	4,10	55/F	-	71

LIVELLI SONORI | SOUND LEVELS dB(A)

Hz		63	125	250	500	1000	2000	4000	8000	TOT
352	Lw	66	78,1	83,6	90	89,2	85,4	77,2	67,1	94
	Lp	51	64	69	75	75	71	63	53	80
354	Lw	51	63,1	71,6	72	74,2	70,4	62,2	52,1	79
	Lp	36	49	57	57	60	56	48	38	64
356	Lw	40,5	55,6	58,1	61,5	63,7	59,9	51,7	41,6	68
	Lp	26	41	44	47	49	45	37	27	53

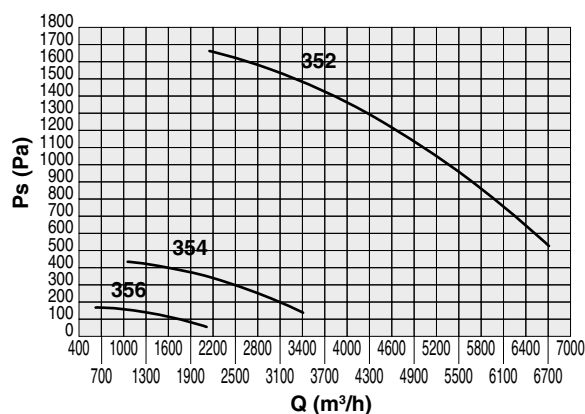

PR-AC 400

Code	Tipo Type	Modello Model	U	P	Pm (kW)	In (A)	IP/CL	IE3	Mot. (Gr)
7PA4098	PR-AC	404	M	4	0,37	2,90	55/F	-	80
7PA4099		404	T	4	0,55	1,60	55/F	-	80
7PA4100		406	T	6	0,25	1,00	55/F	-	71

LIVELLI SONORI | SOUND LEVELS dB(A)

Hz		63	125	250	500	1000	2000	4000	8000	TOT
404	Lw	55,3	67,4	75,9	76,3	78,5	74,7	66,5	56,4	83
	Lp	41	53	61	62	64	60	52	42	68
406	Lw	45,9	61	63,5	66,9	69,1	65,3	57,1	47	73
	Lp	31	46	49	52	55	51	43	32	59

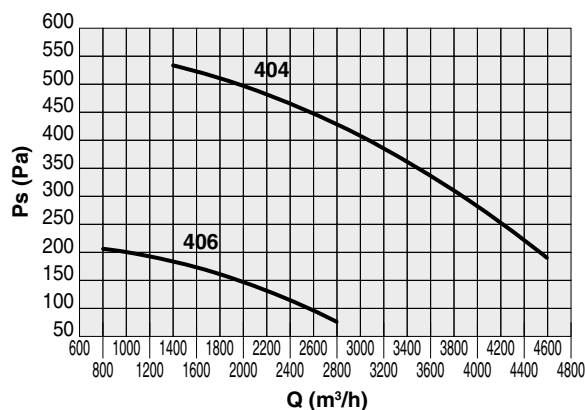

PR-AC 450

Code	Tipo Type	Modello Model	U	P	Pm (kW)	In (A)	IP/CL	IE3	Mot. (Gr)
7PA4603	PR-AC	454	T	4	1,10	2,50	55/F	✓	90S
7PA4604		456	T	6	0,37	1,40	55/F	-	80

LIVELLI SONORI | SOUND LEVELS dB(A)

Hz		63	125	250	500	1000	2000	4000	8000	TOT
454	Lw	55,4	67,5	76	76,4	78,6	74,8	66,6	56,5	83
	Lp	41	53	61	62	64	60	52	42	68
456	Lw	46,1	61,2	63,7	67,1	69,3	65,5	57,3	47,2	73
	Lp	32	47	49	53	55	51	43	33	59

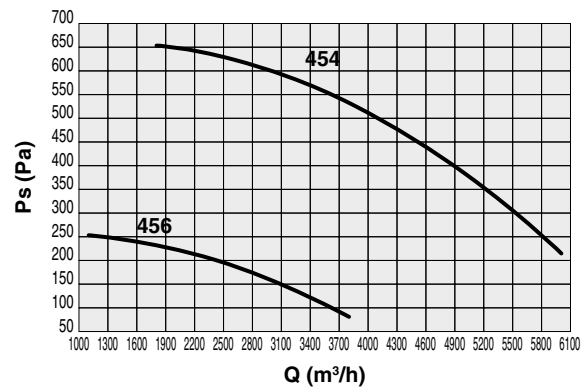

PR-AC 500

Code	Tipo Type	Modello Model	U	P	Pm (kW)	In (A)	IP/CL	IE3	Mot. (Gr)
7PA5064	PR-AC	504	T	4	2,20	4,60	55/F	✓	100L
7PA5065		506	T	6	0,55	1,80	55/F	-	90S

LIVELLI SONORI | SOUND LEVELS dB(A)

Hz		63	125	250	500	1000	2000	4000	8000	TOT
504	Lw	62,8	74,9	83,4	83,8	86	82,2	74	63,9	90
	Lp	48	60	69	69	71	68	59	49	76
506	Lw	53,4	65,5	74	74,4	76,6	72,8	64,6	54,5	81
	Lp	39	51	59	60	62	58	50	40	66

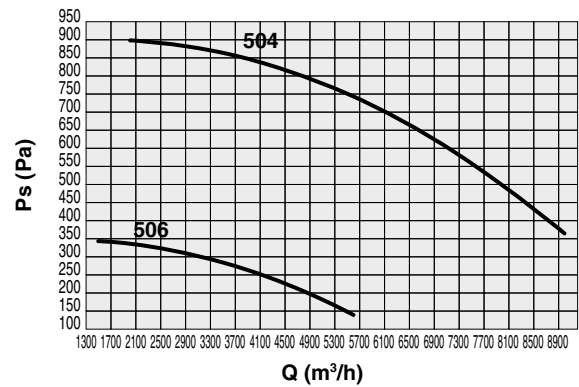

PR-AC 560

Code	Tipo Type	Modello Model	U	P	Pm (kW)	In (A)	IP/CL	IE3	Mot. (Gr)
7PA5665	PR-AC	564	T	4	4,00	8,10	55/F	✓	112M
7PA5666		566	T	6	1,50	3,50	55/F	✓	100L

LIVELLI SONORI | SOUND LEVELS dB(A)

Hz		63	125	250	500	1000	2000	4000	8000	TOT
564	Lw	62,3	74,4	82,9	83,3	85,5	81,7	73,5	63,4	90
	Lp	48	60	68	69	71	67	59	49	75
566	Lw	52,9	65	73,5	73,9	76,1	72,3	64,1	54	80
	Lp	38	50	59	59	62	58	50	39	66

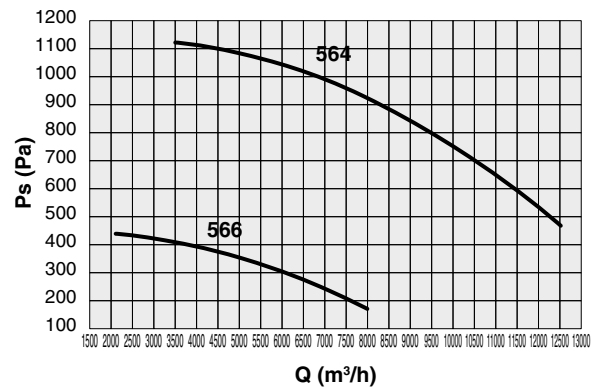

PR-AC 630

Code	Tipo Type	Modello Model	U	P	Pm (kW)	In (A)	IP/CL	IE3	Mot. (Gr)
7PA6355	PR-AC	634	T	4	5,50	10,40	55/F	✓	112M
7PA6356		636	T	6	2,20	5,00	55/F	✓	132S

LIVELLI SONORI | SOUND LEVELS dB(A)

Hz		63	125	250	500	1000	2000	4000	8000	TOT
634	Lw	62,1	74,2	82,7	83,1	85,3	81,5	73,3	63,2	90
	Lp	48	60	68	69	71	67	59	49	75
636	Lw	52,7	64,8	73,3	73,7	75,9	72,1	63,9	53,8	80
	Lp	38	50	59	59	61	58	49	39	66

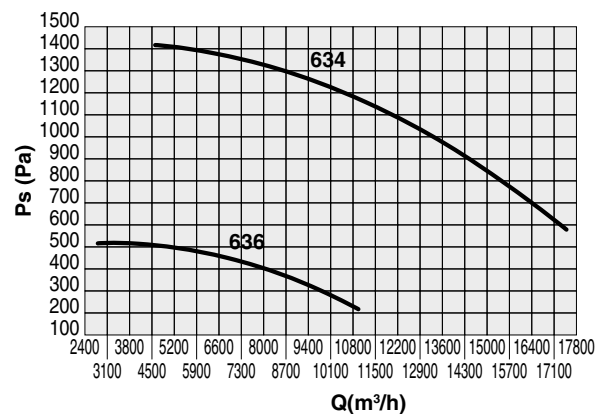

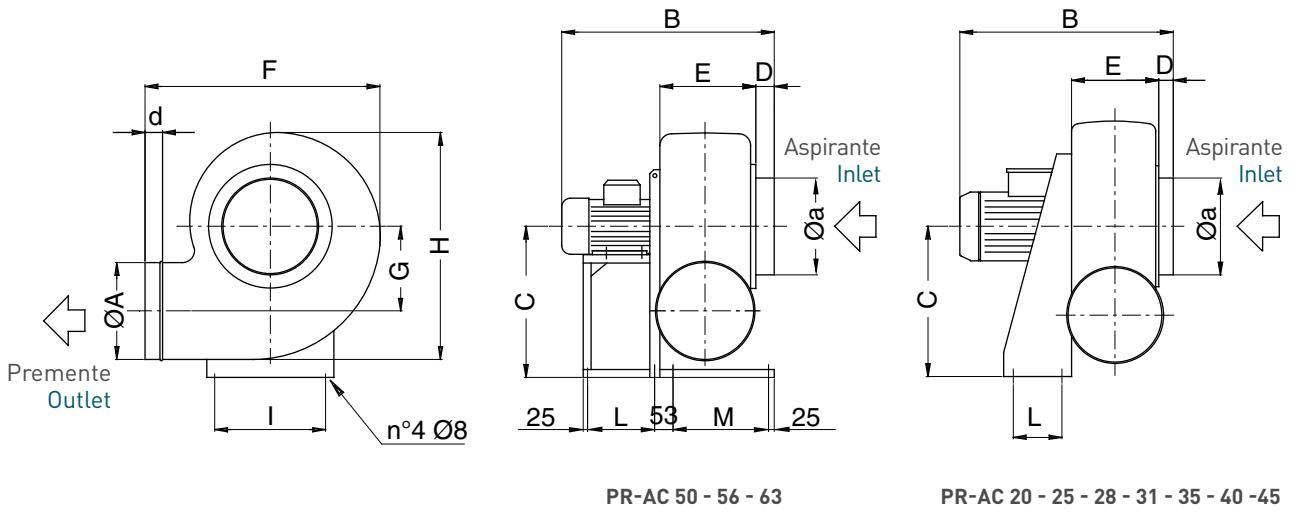

PR-AC 50 - 56 - 63

PR-AC 20 - 25 - 28 - 31 - 35 - 40 - 45

TIPO TYPE	ØA	Øa	B	C	D	d	E	F	G	H	I	L	M	*kg
PR-AC 20	160	160	385	250	35	40	157	373	140	370	200	100	-	17
PR-AC 25	200	200	435	310	35	45	180	452	173	465	255	100	-	24
PR-AC 28	225	225	470	350	40	35	192	515	208	530	280	120	-	33
PR-AC 31	250	250	527	410	40	40	197	560	240	595	320	150	-	45
PR-AC 35	280	280	565	445	40	40	234	600	260	670	355	150	-	51
PR-AC 40	315	315	530	516	40	35	248	675	290	742	330	170	-	47
PR-AC 45	355	355	614	550	40	40	283	750	324	830	368	170	-	61
PR-AC 50	400	400	730	630	50	60	355	840	360	955	290	237	335	77
PR-AC 56	450	450	760	710	50	60	375	930	410	1045	289	270	454	120
PR-AC 63	500	500	887	800	50	60	445	1110	450	1200	337	270	505	131

*Pesi indicativi | Indicative weights

ORIENTAMENTI | DISCHARGE ANGLES

Rotazione Rotation RD						
Forma Form	0°	45°	90°	135°	270°	315°
Rotazione Rotation LG						

N.B.:
Orientamento standard LG270°
Standard discharge angles LG 270°



5SU | GIUNTO ANTIVIBRANTE | ANTIVIBRATION JOINT

Per bocca aspirante e premente, in PVC.
Inlet and outlet, in PVC.

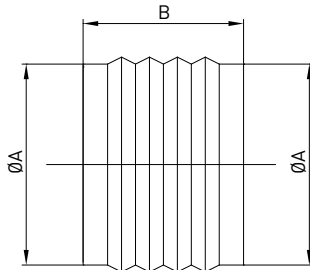

Code	Tipo Type	ØA	B
5SU3020	20	160	160
5SU3025	25	200	160
5SU3028	28	225	160
5SU3030	31	250	160
5SU3036	35	280	160
5SU3040	40	315	160
5SU3045	45	355	160
5SU3054	50	400	160
5SU3056	56	450	160
5SU3063	63	500	160

Dimensioni in mm | Dimensions in mm

1SE | SERRANDA A GRAVITÀ | GRAVITY SHUTTER

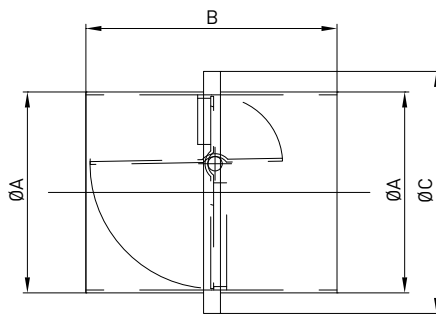

Code	Tipo Type	ØA	B	ØC
1SE2021	20	160	200	240
1SE2026	25	200	200	280
1SE2028	28	225	200	305
1SE2031	31	250	200	330
1SE2035	35	280	200	360
1SE2040	40	315	210	435
1SE2045	45	355	210	475
1SE2049	50	400	210	520
(1)	56	450	210	570
(1)	63	500	210	620

(1) Codice a richiesta. Dimensioni in mm
(1) Item code upon request. Dimensions in mm

1SE | SERRANDA MANUALE | MANUAL SETTING SHUTTER

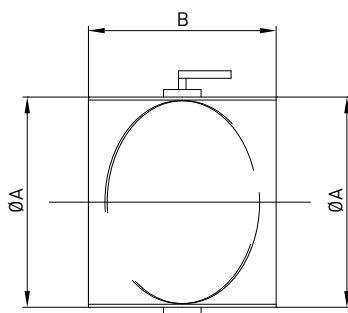

Code	Tipo Type	ØA	B
1SE2022	20	160	120
1SE2027	25	200	120
1SE2030	28	225	120
1SE2032	31	250	120
1SE2036	35	280	140
1SE2041	40	315	140
1SE2046	45	355	140
1SE2050	50	400	140
(1)	56	450	440
(1)	63	500	480

Dimensioni in mm | Dimensions in mm

5RE | RETE DI PROTEZIONE | PROTECTION GUARD

In acciaio inox.
In stainless steel.

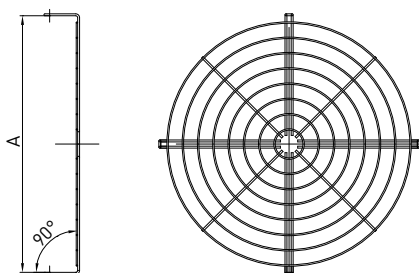

Code	Tipo Type	ØA
5RE2002	20	160
5RE2552	25	200
5RE2802	28	225
5RE2029	31	250
5RE2502	35	280
5RE4004	40	315
5RE4504	45	355
5RE5008	50	400
5RE5600	56	450
5RE6300	63	500

Dimensioni in mm | Dimensions in mm