



# REC PRO 75

High efficiency heat recovery units  
Non residential applications



Comply with ErP Directive 125/2009/CE and EU Regulation 1253/2014.

Classification: Non Residential Ventilation Unit (NRVU). Bidirectional Ventilation Unit (BVU).

- 7 sizes
- Airflow from 450 to max 5.500 m<sup>3</sup>/h
- Vertical and Horizontal models
- Motor EC 

## ELECTRONIC CONTROL

The control is already mounted and wired to the unit, complete with electronic controller, remote user interface with built-in temperature sensor, 4 NTC sensors and protection fuses.

### Functions:

- Manual or automatic fan speed control
- Heating/cooling 3-point valves control (or on/off electric heater)
- Free-cooling management
- Water coil antifreeze management
- Recovery defrost management
- Humidifier and water cooler management
- Alarm management
- Weekly clock setting
- BMS by Modbus - RS485 connection



## DESCRIPTION

The heat recovery units of the **REC PRO 75** series are designed to match the need to equip the buildings with ventilation systems which can combine low energy consumption, high aeratic performance and high indoor air quality.

In accordance with the new EU 1253/2014 norm, they are equipped with a high efficiency counter-flow plate heat recovery unit (in dry conditions, superior to the minimum efficiency prescribed by the law of 67%), with filters with extremely low pressure drops (F7 on fresh air and M5 on room air exhaust, efficiency calculated according to EN 779:2012) and with backward-curved blades fans, directly coupled with EC motors, guaranteeing power absorptions well below the limits indicated by the norm.

They can easily be integrated with conventional heating and air-conditioning systems and their construction is optimized for a ducted installation in false ceilings and for an all-seasons operation.

The series is available in both vertical and horizontal configuration and in 6 sizes with performances ranking from 450 to max 5,500 m<sup>3</sup>/h.

## CONSTRUCTION

- The casing is made with double skin panels, with 25mm thick rockwool insulation with fire reaction class A2S1d0; external panels are in prepainted steel, internal panels in galvanized steel.
- Integrated by-pass system with actuator, for free-cooling operations.
- Access to fans and filters sections is ensured by doors with hinges and locking devices; additional access is given to the filters thanks to lift-off panels.
- The units are complete with an electronic control device for the setting of the ventilation and temperature, monitoring of the status of the filters, week programming, defrost management and anti-freeze device for the additional water coil module.

## UPON REQUEST

REC 75 can be supplied with the following function components, assembled and connected, to be requested in stage of order:

- **PSTD** - Filters differential pressure switch.
- **DPS** - Differential pressure sensor.
- **AQS** - Ductable CO<sub>2</sub> probe.

## RANGE

HORIZONTAL VERSIONS		VERTICAL VERSIONS	
CODE	MODEL	CODE	MODEL
1RC7000	REC PRO 75-450	1RC7006	REC/V PRO 75-450
1RC7001	REC PRO 75-800	1RC7007	REC/V PRO 75-800
1RC7002	REC PRO 75-1300	1RC7008	REC/V PRO 75-1300
1RC7003	REC PRO 75-1900	1RC7009	REC/V PRO 75-1900
1RC7004	REC PRO 75-2800	1RC7010	REC/V PRO 75-2800
1RC7005	REC PRO 75-3800	1RC7011	REC/V PRO 75-3800
1RC7021	REC PRO 75-5400	1RC7022	REC/V PRO 75-5400

# DIMENSIONS (mm)

## Horizontal versions

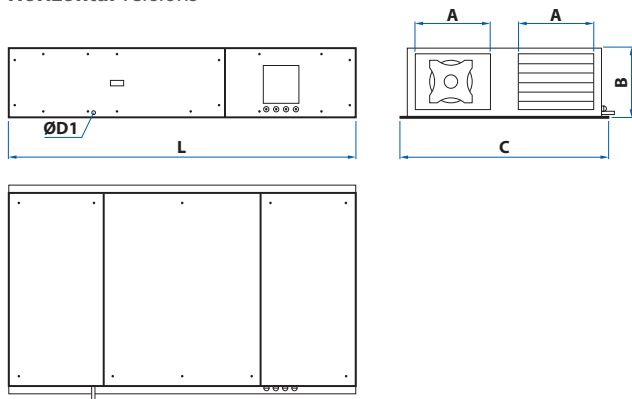

CODE	MODEL	A	B	C	D	L	KG
1RC7000	75-450	230	330	760	½" M	1350	85
1RC7001	75-800	300	370	900	½" M	1470	105
1RC7002	75-1300	390	455	1110	½" M	1850	175
1RC7003	75-1900	600	455	1540	½" M	1850	230
1RC7004	75-2800	590	590	1540	½" M	2150	290
1RC7005	75-3800	780	590	1920	½" M	2150	360
1RC7021	75-5400	800	720	1980	½" M	2350	520

## Vertical versions

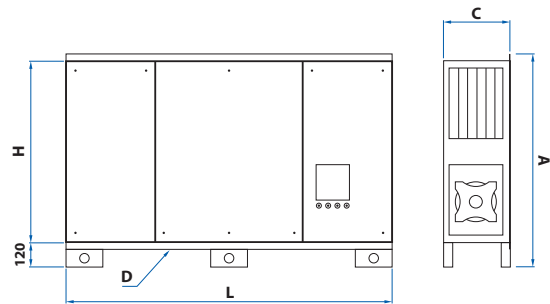

CODE	MODEL	A	C	D	H	L	KG
1RC7006	75-450	680	330	½" M	680	1350	85
1RC7007	75-800	822	370	½" M	820	1470	105
1RC7008	75-1300	1030	455	½" M	1030	1850	175
1RC7009	75-1900	1462	455	½" M	1460	1850	230
1RC7010	75-2800	1460	590	½" M	1460	2150	290
1RC7011	75-3800	1840	590	½" M	1840	2150	360
1RC7022	75-5400	1900	720	½" M	1900	2350	520

# CONFIGURATIONS

## HORIZONTAL EXECUTION - TYPE A ORIENTATION

- (1) External air (F7 filter)
- (2) Output fan
- (3) Input fan
- (4) Intake (M5 Filter)

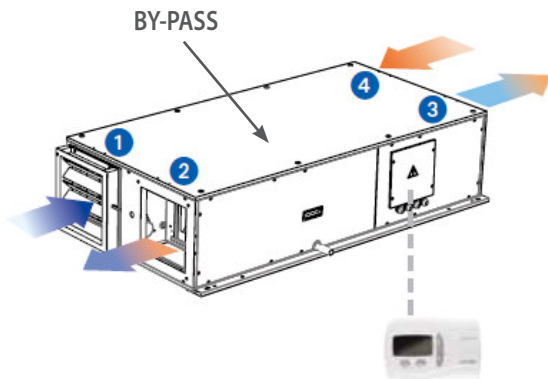

## HORIZONTAL EXECUTION - TYPE B ORIENTATION

- (1) External air (F7 filter)
- (2) Output fan
- (3) Input fan
- (4) Intake (M5 Filter)

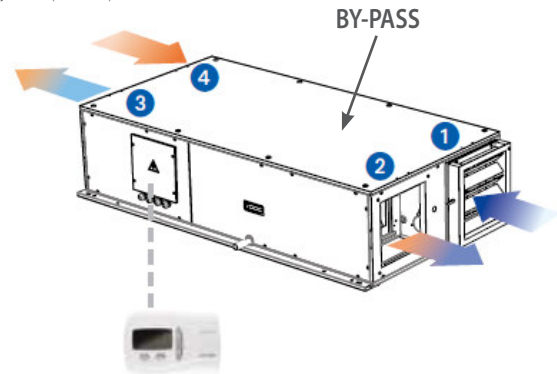

## VERTICAL EXECUTION - TYPE C ORIENTATION

- (1) External air (F7 filter)
- (2) Output fan
- (3) Input fan
- (4) Intake (M5 Filter)

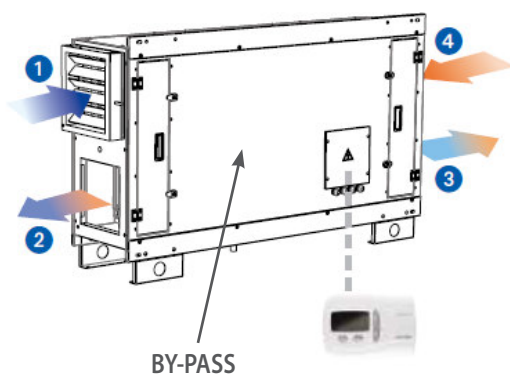

## VERTICAL EXECUTION - TYPE D ORIENTATION

- (1) External air (F7 filter)
- (2) Output fan
- (3) Input fan
- (4) Intake (M5 Filter)

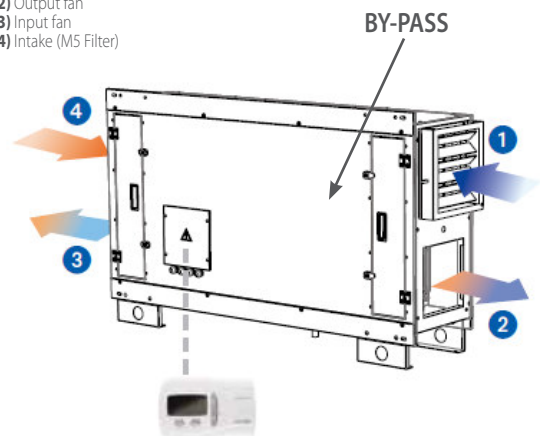

# PERFORMANCE

The following curves represent the intake static pressures erogated by the units according to the airflow change (100%, 80%, 60% of the nominal speed) and the working area at the maximum ventilation speed. All performances reported refer to clean filters periodically cleaned.

REC PRO 75 - 450

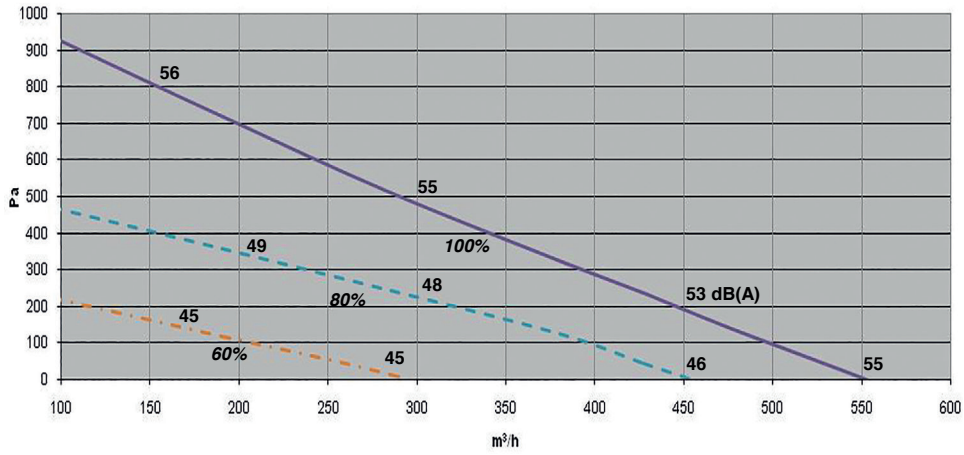

REC PRO 75 - 800

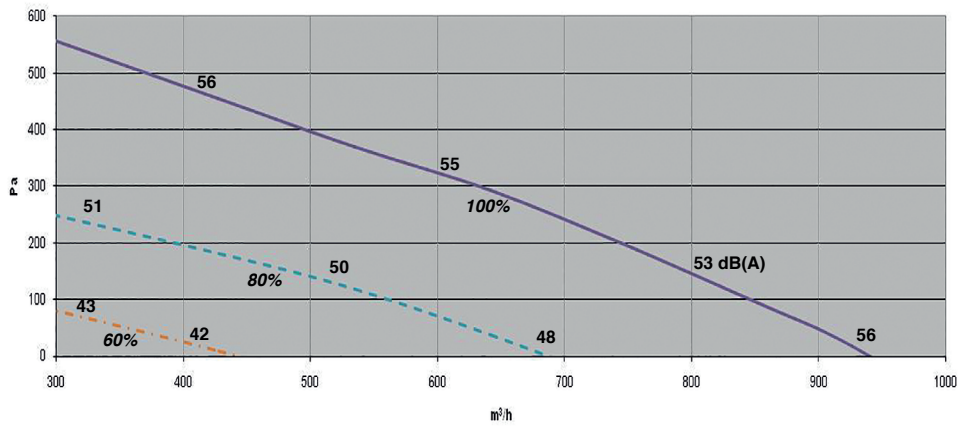

REC PRO 75 - 1300

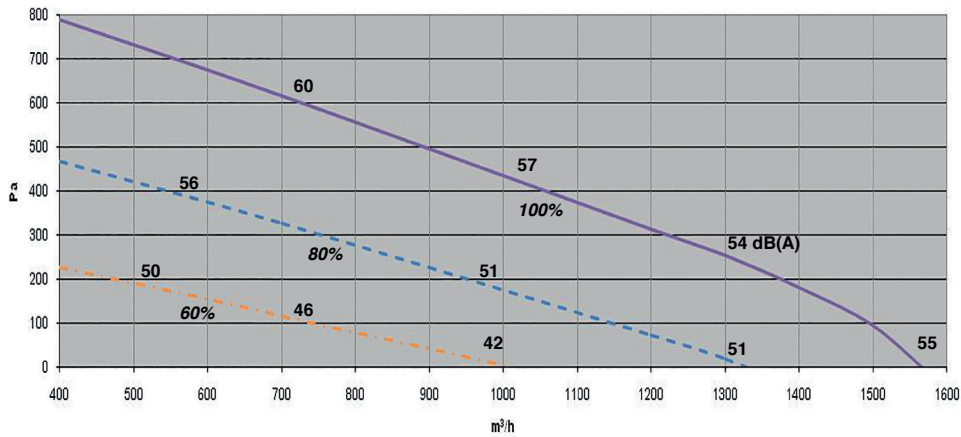

# PERFORMANCE

REC PRO 75 - 1900

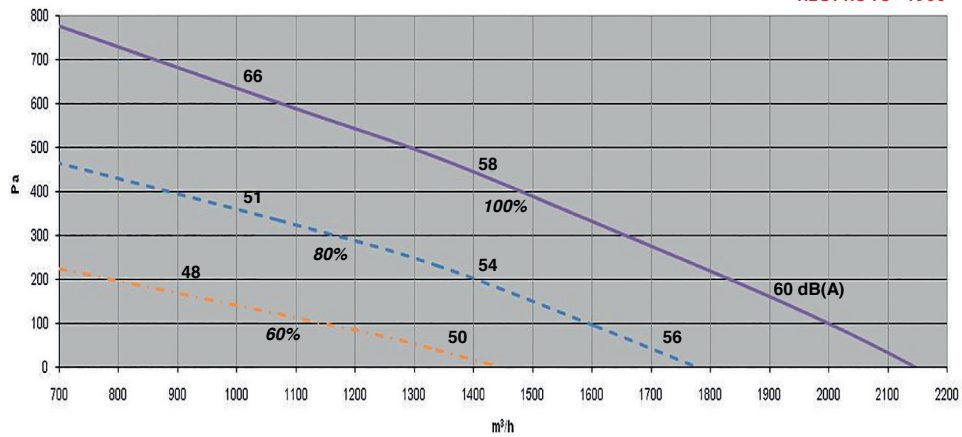

REC PRO 75 - 2800

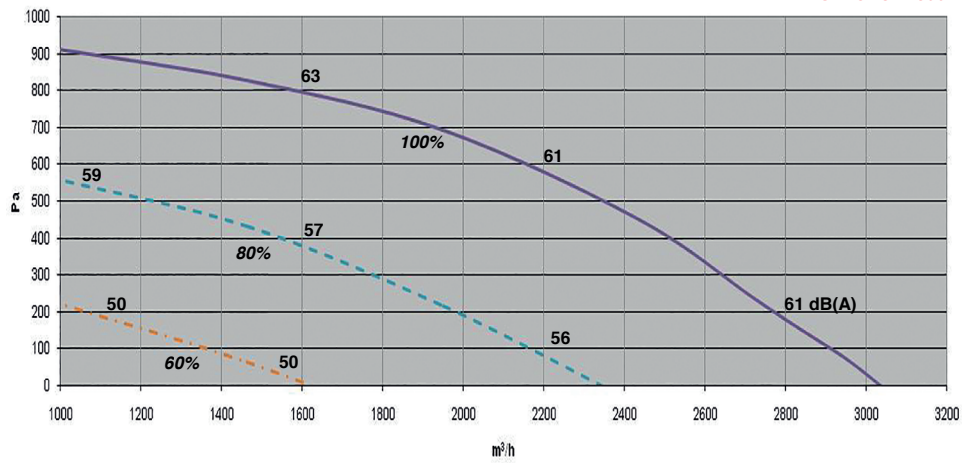

REC PRO 75 - 3800

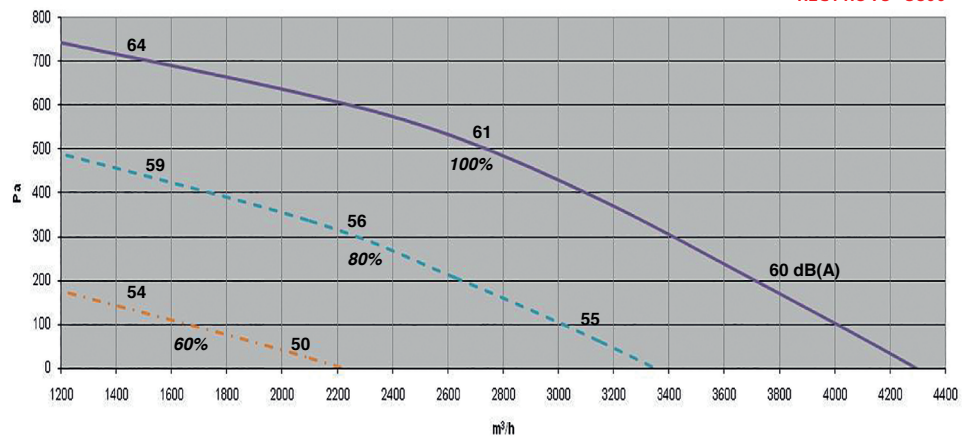

REC PRO 75 - 5400

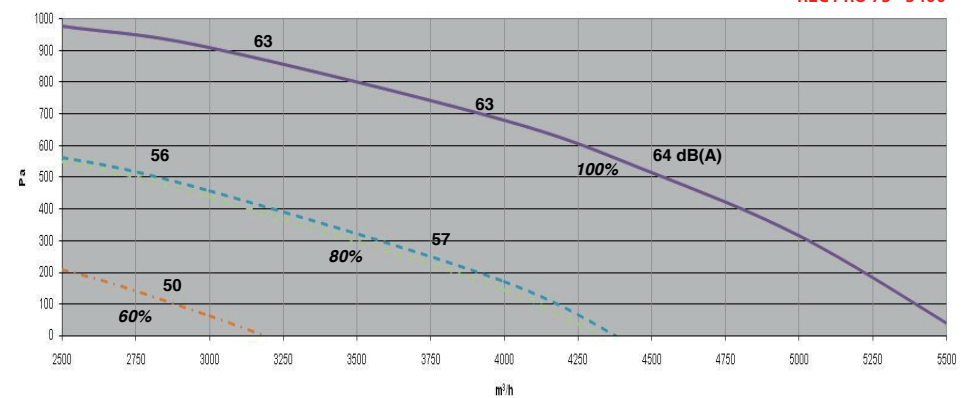

# PERFORMANCE AND ErP CONFORMITY

EU Regulation 1253/2014

VENTILATION			75-450	75-800	75-1300	75-1900	75-2800	75-3800	75-5400	
Airflow	Nom	m³/h m³/s	450 0,125	800 0,222	1300 0,361	1900 0,528	2800 0,778	3800 1,056	4500 1,25	
	Max	m³/h	550	930	1560	2150	3050	4300	5500	
External static pressure (1)	Nom	Pa	200	160	250	170	190	175	510	
Sound pressure level 1m	Nom	dB(A)	53	53	54	60	61	60	64	
Overall power input	Nom	W	330	340	920	930	1820	1920	3010	
	Max		340	340	920	930	2000	2000	4850	
Overall input current total	Nom	A	2,7	2,9	6,0	6,0	3,2	3,4	4,7	
	Max		2,8	2,9	6,0	6,0	3,4	3,5	7,6	
Power supply	V-Ph-Hz	230-1-50					400-3+N-50			
Fan speed control	-	0÷10 V								
External leakage	max 3,5% @ -400 Pa (EN 13141-7)									
Internal leakage	max 5,5% @ +250 Pa (EN 13141-7)									
Yearly filter energy consumption (5)	kWh	476	719	1332	2065	2482	3259	3180		
HEAT RECOVERY (2)			75-450	75-800	75-1300	75-1900	75-2800	75-3800	75-5400	
Recovery efficiency	%	86,5	83,4	83,7	84,1	83,4	83,2	86,3		
Recovery capacity	W	3520	6040	9840	14450	21120	28600	33800		
Supply temperature	°C	16,3	15,5	15,6	15,7	15,5	15,5	16,3		
CONFORMITY TO EU 1253/2014			75-450	75-800	75-1300	75-1900	75-2800	75-3800	75-5400	
Recovery efficiency (3)	%	79,0	76,0	76,2	76,5	76,0	75,8	77,6		
Efficiency bonus	W/m³/s	360	270	276	285	270	264	138		
Filter correction factor	-	0	0	0	0	0	0	0		
SFP int-lim	W/m³/s	1541	1437	1422	1406	1353	1306	1050		
Total internal air pressure drop (3)	Pa	725	755	693	645	762	761	534		
Overall fan static efficiency (4)	%	47,3	55,6	48,8	46,0	56,4	58,3	62,0		
SFP int	W/m³/s	1533	1359	1420	1405	1351	1305	861		
OPERATION LIMITS			75-450	75-800	75-1300	75-1900	75-2800	75-3800	75-5400	
Air temperature	°C	-20 ÷ 45								
Air Relative Humidity	%	10 ÷ 95								
Working environment	-	Not explosive, not corrosive, not chlorinated, not saline								

- (1) Fresh air/supply air circuit.  
 (2) At wet conditions: outside air temperature -7°C 80% RH, room air temperature 20°C 55% RH.  
 (3) At dry conditions: outside air temperature 5°C, room air temperature 25°C.  
 (4) Including motor & speed controller efficiency.  
 (5) At nominal airflow rate.

## SOUND LEVELS

The table lists the sound power values (SWL) in octave bands and totals; it also indicates the values of sound pressure level (SPL) at 1 m, 5 m and 10 m at supply, return and at the outside of the unit. All values refer to the operation of the ducted unit at FULL speed and at the nominal flow rate.

MODEL	Hz	63	125	250	500	1000	2000	4000	8000	Tot SWL		Output			Input			Outside		
										dB	dB(A)	1 m	5 m	10 m	1 m	5 m	10 m	1 m	5 m	10 m
												dB(A)	dB(A)	dB(A)	dB(A)	dB(A)	dB(A)	dB(A)	dB(A)	dB(A)
75-450	LwdB(A)	62	59	65	65	63	63	62	53	72	69	61	47	41	53	39	33	44	30	24
75-800	LwdB(A)	61	58	64	64	62	62	61	53	71	68	60	47	41	53	39	33	44	30	24
75-1300	LwdB(A)	60	59	65	65	63	63	63	55	72	70	61	48	42	54	40	32	45	31	25
75-1900	LwdB(A)	66	64	74	73	69	68	68	67	79	76	68	54	48	60	46	40	51	37	31
75-2800	LwdB(A)	69	66	74	76	72	71	67	67	81	77	69	55	49	61	47	41	52	38	32
75-3800	LwdB(A)	68	68	72	73	69	70	66	65	79	76	68	54	48	60	46	40	51	37	31
75-5400	LwdB(A)	70	68	80	75	70	70	67	70	83	79	72	58	52	64	50	44	55	41	35

# REC PRO 75 ACCESSORIES

<b>SKE</b>	Electric heater
<b>CCS-H / CCS-V</b>	External module with water coil
<b>V33</b>	Modulating 3-way valve with actuator
<b>CDX-H / CDX-V</b>	External module of heating / cooling with R410A direct expansion coil
<b>PLM</b>	Plenum with multiple connections
<b>SKR1 / SKR2</b>	<b>Adjusting damper - SKR 1:</b> Front / upper - lower (with plenum) air damper - <b>SKR 2:</b> side (with plenum) air damper
<b>SSE</b>	On/Off damper actuator (supplied assembled and connected to the SKR if requested)
<b>GAT1 / GAT2</b>	<b>Flexible connection - GAT 1:</b> Front / upper - lower (with plenum) flexible connection - <b>GAT 2:</b> Side flexible connection (with plenum)
<b>BCC1 / BCC2</b>	<b>Round adaptor - BCC 1:</b> Front / upper - lower (with plenum) round adaptor for circular ducts - <b>BCC 2:</b> Side round adaptor for circular ducts (with plenum)
<b>TPR-H / TPR-V</b>	Roof cover

Code	Models	SKE	CCS-H	CCS-V	V33	CDX-H	CDX-V	PLM	SKR1 (1)	SKR2 (1)	SSE (2)	GAT1	GAT2	BCC1	BCC2	TPR-H	TPR-CH	TPR-V	TPR-CV
------	--------	-----	-------	-------	-----	-------	-------	-----	----------	----------	---------	------	------	------	------	-------	--------	-------	--------

## REC PRO 75 - Horizontal versions

<b>1RC7000</b>	<b>REC PRO 75-450</b>	SBT0070	SBT0076	NA	SBT0088	SBT0094	NA	SPL0070	SSE0070	SSE0076	Supplied with SKR1/2	SSU0070	SSU0076	SBC0070	SBC0076	STE0220	STE0226	NA	NA
<b>1RC7001</b>	<b>REC PRO 75-800</b>	SBT0071	SBT0077	NA	SBT0089	SBT0095	NA	SPL0071	SSE0071	SSE0077	Supplied with SKR1/2	SSU0071	SSU0077	SBC0071	SBC0077	STE0221	STE0227	NA	NA
<b>1RC7002</b>	<b>REC PRO 75-1250</b>	SBT0072	SBT0078	NA	SBT0090	SBT0096	NA	SPL0072	SSE0072	SSE0078	Supplied with SKR1/2	SSU0072	SSU0078	SBC0072	SBC0078	STE0222	STE0228	NA	NA
<b>1RC7003</b>	<b>REC PRO 75-1750</b>	SBT0073	SBT0079	NA	SBT0091	SBT0097	NA	SPL0073	SSE0073	SSE0079	Supplied with SKR1/2	SSU0073	SSU0079	SBC0073	SBC0079	STE0223	STE0229	NA	NA
<b>1RC7004</b>	<b>REC PRO 75-2800</b>	SBT0074	SBT0080	NA	SBT0092	SBT0098	NA	SPL0074	SSE0074	SSE0080	Supplied with SKR1/2	SSU0074	SSU0080	SBC0074	SBC0080	STE0224	STE0230	NA	NA
<b>1RC7005</b>	<b>REC PRO 75-3800</b>	SBT0075	SBT0081	NA	SBT0093	SBT0099	NA	SPL0075	SSE0075	SSE0081	Supplied with SKR1/2	SSU0075	SSU0081	SBC0075	SBC0081	STE0225	STE0231	NA	NA
<b>1RC7021</b>	<b>REC PRO 75-5400</b>	SBT0069	SBT0123	NA	SBT0143	SBT0125	NA	SPL0082	SSE0089	SSE0090	Supplied with SKR1/2	SSU0088	SSU0089	SBC0069	SBC0068	STE0219	STE0218	NA	NA

## REC PRO 75 - Vertical versions

<b>1RC7006</b>	<b>REC/V PRO 75-450</b>	SBT0070	NA	SBT0082	SBT0088	NA	SBT0100	SPL0070	SSE0070	SSE0076	Supplied with SKR1/2	SSU0070	SSU0076	SBC0070	SBC0076	NA	NA	STE0232	STE0238
<b>1RC7007</b>	<b>REC/V PRO 75-800</b>	SBT0071	NA	SBT0083	SBT0089	NA	SBT0101	SPL0071	SSE0071	SSE0077	Supplied with SKR1/2	SSU0071	SSU0077	SBC0071	SBC0077	NA	NA	STE0233	STE0239
<b>1RC7008</b>	<b>REC/V PRO 75-1250</b>	SBT0072	NA	SBT0084	SBT0090	NA	SBT0102	SPL0072	SSE0072	SSE0078	Supplied with SKR1/2	SSU0072	SSU0078	SBC0072	SBC0078	NA	NA	STE0234	STE0240
<b>1RC7009</b>	<b>REC/V PRO 75-1750</b>	SBT0073	NA	SBT0085	SBT0091	NA	SBT0103	SPL0073	SSE0073	SSE0079	Supplied with SKR1/2	SSU0073	SSU0079	SBC0073	SBC0079	NA	NA	STE0235	STE0241
<b>1RC7010</b>	<b>REC/V PRO 75-2800</b>	SBT0074	NA	SBT0086	SBT0092	NA	SBT0104	SPL0074	SSE0074	SSE0080	Supplied with SKR1/2	SSU0074	SSU0080	SBC0074	SBC0080	NA	NA	STE0236	STE0242
<b>1RC7011</b>	<b>REC/V PRO 75-3800</b>	SBT0075	NA	SBT0087	SBT0093	NA	SBT0105	SPL0075	SSE0075	SSE0081	Supplied with SKR1/2	SSU0075	SSU0081	SBC0075	SBC0081	NA	NA	STE0237	STE0243
<b>1RC7022</b>	<b>REC/V PRO 75-5400</b>	SBT0069	NA	SBT0118	SBT0143	NA	SBT0126	SPL0082	SSE0089	SSE0090	Supplied with SKR1/2	SSU0088	SSU0089	SBC0069	SBC0068	NA	NA	STE0217	STE0216

NA = Not Applicable

(1) The dampers are supplied without actuator. SSE actuator can be assembled if requested in phase of order.

(2) The actuator is not supplied separately but assembled on the dampers SKR1 and SKR2, if requested.

## SKE - Electric heater

The type of heater is with filament elements, made in galvanized steel frame inserted in the unit with function of pre and / or post-heating and equipped with a safety thermostat with automatic and manual reset.

MODEL		<b>SKE - 450</b>	<b>SKE - 800</b>	<b>SKE - 1250</b>	<b>SKE - 1900</b>	<b>SKE - 2800</b>	<b>SKE - 3800</b>	<b>SKE - 5400</b>	
<b>Code</b>		<b>SBT0070</b>	<b>SBT0071</b>	<b>SBT0072</b>	<b>SBT0073</b>	<b>SBT0074</b>	<b>SBT0075</b>	<b>SBT0069</b>	
<b>Power</b>	kW	1,5	2,5	4,0	5,0	7,5	10,5	12,5	
<b>ΔT (1)</b>	°C	9,8	9,2	9,0	7,7	7,9	8,1	8,1	
<b>Pressure loss air intake side (1)</b>	Pa	5	6	10	10	11	12	12	
<b>Power supply</b>	V-ph-Hz	230-1-50					400-3-50		

(1) at nominal airflow

## CCS-H / CCS-V

### External heating/cooling water coil

External module with water coil (CCS-H: for horizontal version units, CCS-V: for vertical version units) that interfaces directly to the inlet/extract side. The 3 rows water coil includes a condensate collection tray in aluminum and is suitable for the treatment of both heating and cooling.

MODEL		<b>75-450</b>	<b>75-800</b>	<b>75-1300</b>	<b>75-1900</b>	<b>75-2800</b>	<b>75-3800</b>	<b>75-5400</b>
<b>Code CCS-H</b>		<b>SBT0076</b>	<b>SBT0077</b>	<b>SBT0078</b>	<b>SBT0079</b>	<b>SBT0080</b>	<b>SBT0081</b>	<b>SBT0123</b>
<b>Code CCS-V</b>		<b>SBT0082</b>	<b>SBT0083</b>	<b>SBT0084</b>	<b>SBT0085</b>	<b>SBT0086</b>	<b>SBT0087</b>	<b>SBT0118</b>
<b>Cooling capacity (1)</b>	total	2,46	4,47	6,83	10,62	16,14	20,68	26,29
	sensible	1,35	2,41	3,76	5,84	8,72	11,37	14,20
<b>Thermal capacity (2)</b>	kW	3,30	5,86	9,34	14,03	20,83	27,50	33,36
<b>Water flow (1)</b>	l/h	432	756	1188	1836	2772	3564	4500
<b>Pressure loss air intake side (1)</b>	kPa	12	18	9	13	19	15	33
<b>Pressure loss air intake side (1)</b>	Pa	51	53	54	50	50	55	54
<b>Weight</b>	Kg	28	31	35	42	52	58	77

(1) air intake 28,0°C 60% RH; water in/out 7°/12°C

(2) air intake 13°C; water in/out 45°/40°

# REC PRO 75 ACCESSORIES

## V33 - 3-step-valve for ventilation unit control

The kit includes a 3-way valve to regulate the water flow, combinable with the external module CCS, and a modulating electric actuator. the connection fittings are not supplied (to be supplied by the installer).

MODEL		V33-450	V33-800	V33-1300	V33-1900	V33-2800	V33-3800	V33-5400
CODE		5BT0088	5BT0089	5BT0090	5BT0091	5BT0092	5BT0093	5BT0143
Nominal pressure	-	PN16 (ISO7286/EN1333)						
Stroke	mm	2,5				5,5		
Hydraulic connection	GAS	3/4" F		3/4" F		1" F		
Kvs	m <sup>3</sup> /h	2,5		4,0		10,0		
Fluid temperature	°C	+2 ÷ +95 (glic. max 40%)						
Power supply	V - Hz	24cc - 50/60						
Regulation signal	V	0 ÷ 10						

## CDX-H / CDX-V - External module with R410A direct expansion coil

External module (CDX-H: for horizontal version units, CDX-V: for vertical version units) that interfaces directly to the inlet/extract side. It includes a 3 row DX coil provided with a condensate collection tray in aluminum (suitable for R410A), suitable to the treatment of both heating and cooling, and tub of aluminum condensate collection.

MODEL		75-450	75-800	75-1300	75-1900	75-2800	75-3800	75-5400
Code CDX-H		5BT0094	5BT0095	5BT0096	5BT0097	5BT0098	5BT0099	5BT0125
Code CDX-V		5BT0100	5BT0101	5BT0102	5BT0103	5BT0104	5BT0105	5BT0126
Potenza frigorifera (1)	total	2,51	4,36	6,96	10,94	16,11	21,22	25,31
	sensible	1,41	2,44	3,90	6,13	9,02	11,88	14,17
Potenza termica (2)	kW	3,33	5,71	9,01	13,90	20,36	26,50	31,72
Portata di carico lato aria (1)	Pa	51	53	51	50	50	55	43
Connessioni a saldare	mm	8/8	12/16	12/16	12/16	16/22	22/28	22/28
Weight	kg	28	31	35	42	52	58	76

(1) incoming air at 28,0°C 60% UR; evaporating temperature 8°C

(2) incoming air at 13°C; condensation temperature 45°C

# REC PRO 75 ACCESSORIES

## PLM - Plenum with multiple connections

External module that can be mounted on both sides of the ventilation unit (horizontal or vertical) allowing the incoming or exhausting of the air on all sides. Can be completed with SKR1/SKR2 dampers and electrical actuators SSE.

CODE	TYPE	KG	NOMINAL PRESSURE LOSS (CURVE AT 90°) PA
5PL0070	75-450	21	6
5PL0071	75-800	23	9
5PL0072	75-1250	26	19
5PL0073	75-1900	30	14
5PL0074	75-2800	39	8
5PL0075	75-3800	44	14
5PL0082	75-5400	59	12

The plenum is provided with 10 possible aeraulic connections (6 of which are closed by insulated plates A) blocked with self-drilling screws as indicated in the following figure:

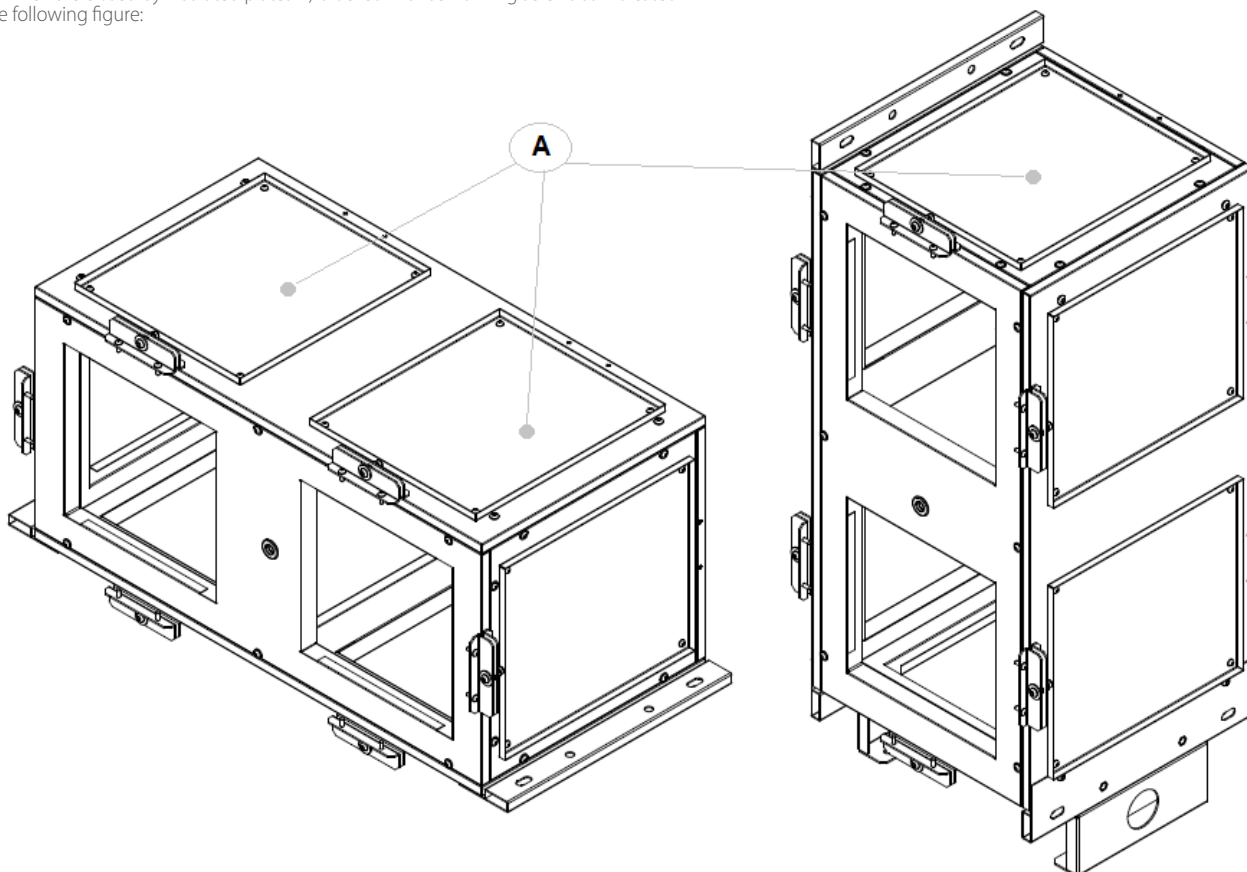



# REC PRO 75 ACCESSORIES

Example of installation:

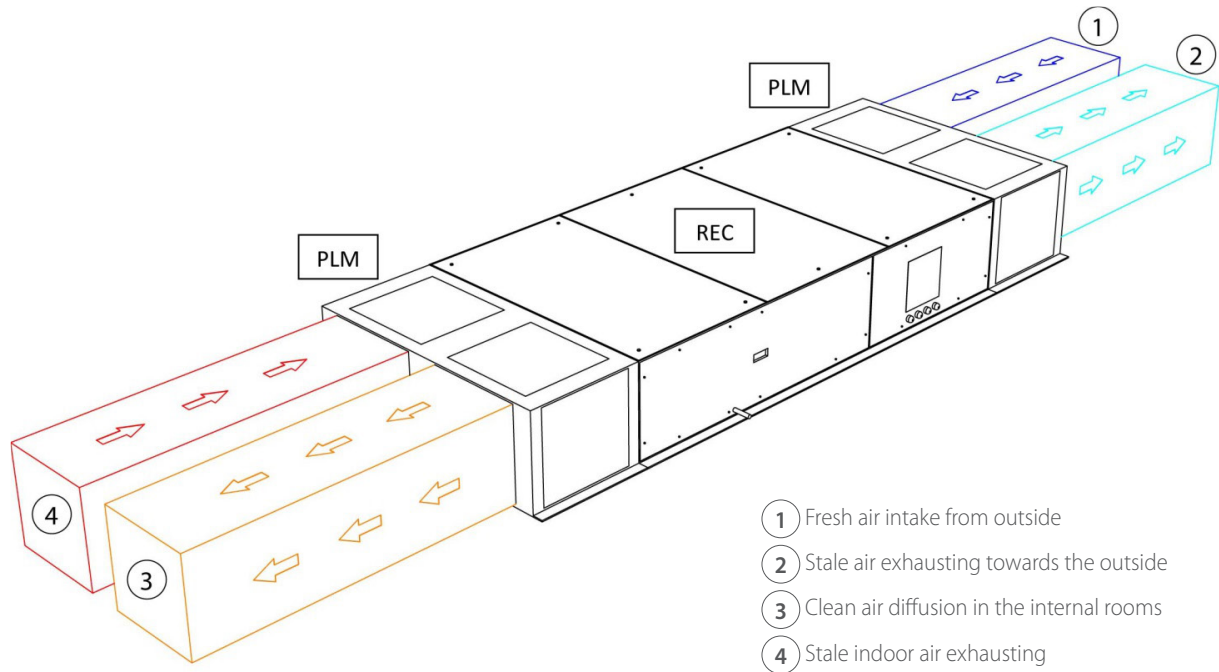

Remove and block again the plates on the unused connections in order to create the desired layout. This operation has to be made before positioning the plenum.

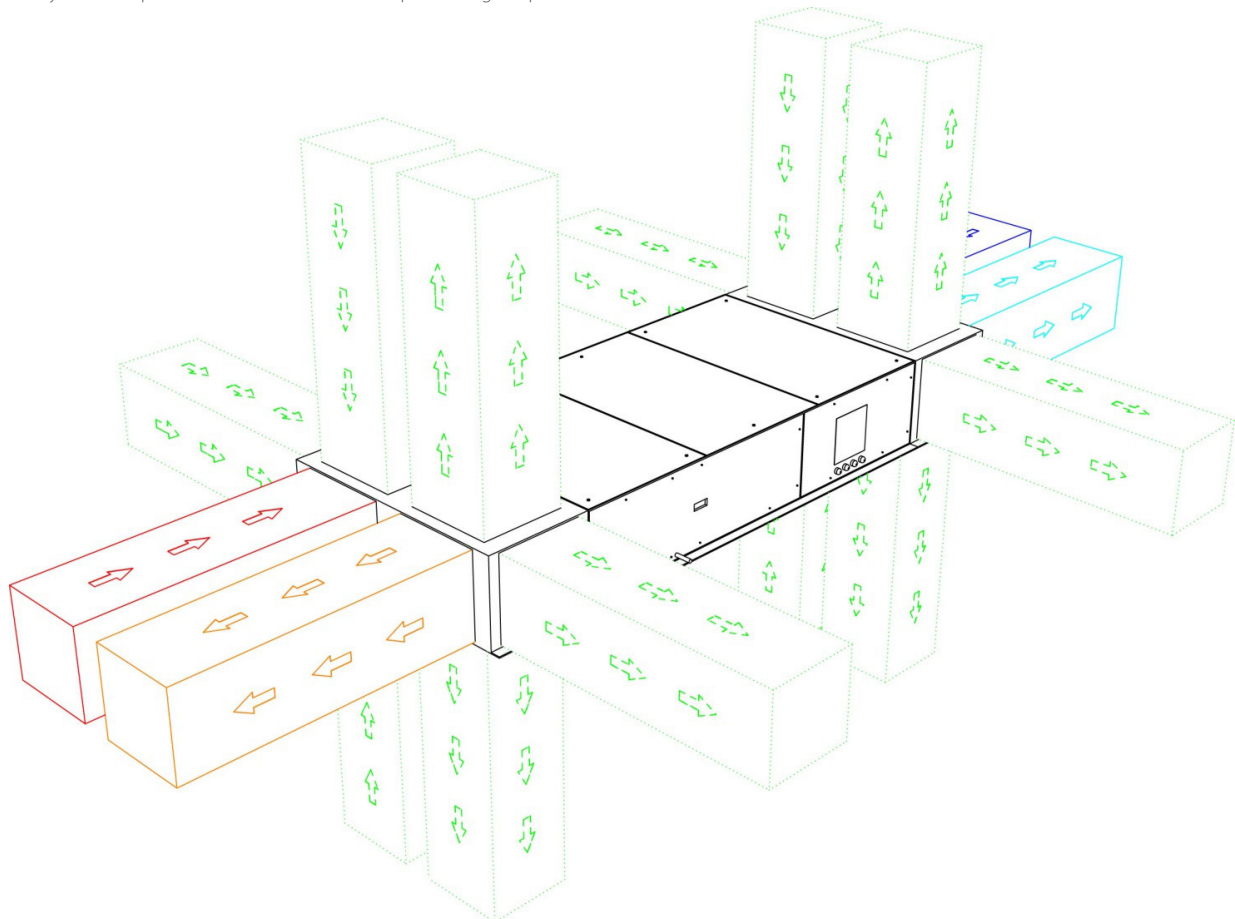

# REC PRO 75 ACCESSORIES

## SKR1 (Front) / SKR2 (Lateral) - Ad justing Dampers

Made of the frame and opposing aluminum fins, with pin for coupling to the electrical actuator.

It can be installed directly on each unit air inlets, in those of the plenum (PLM) or CCS / CDX modules.

**SKR 1:** Front / upper - lower (with plenum) air damper. **SKR 2:** side air damper (with plenum).

The dampers are supplied without actuator. If requested SSE actuator can be supplied assembled on the dampers.

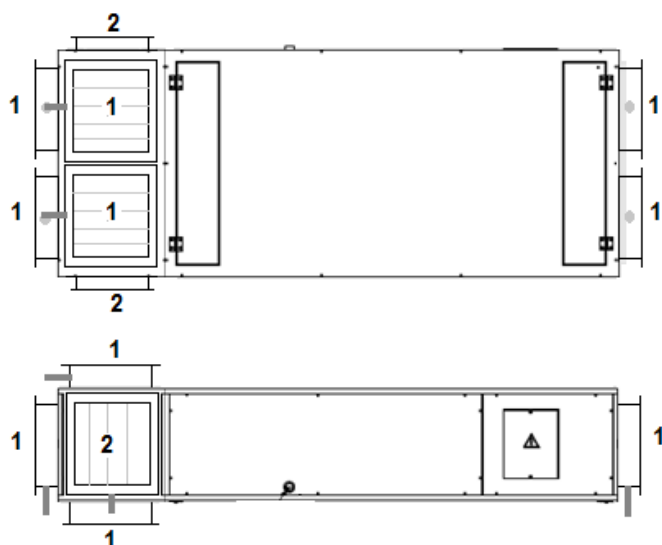

1=SKR1  
2=SKR2

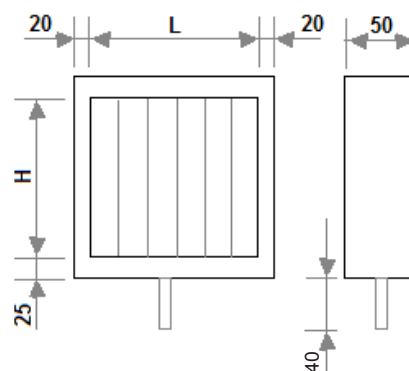

CODE	TYPE 1	AIR PASSAGE L X H	KG
5SE0070	SKR1 75-450	250x230	1.6
5SE0071	SKR1 75-800	290x270	2.1
5SE0072	SKR1 75-1300	370x355	2.6
5SE0073	SKR1 75-1900	610x355	3.7
5SE0074	SKR1 75-2800	610x490	4.3
5SE0075	SKR1 75-3800	770x490	6.2
5SE0089	SKR1 75-5400	810x720	8.1

CODE	TYPE 2	AIR PASSAGE L X H	KG
5SE0076	SKR2 75-450	250x230	1.6
5SE0077	SKR2 75-800	290x270	2.0
5SE0078	SKR2 75-1300	370x355	2.6
5SE0079	SKR2 75-1900	370x355	2.9
5SE0080	SKR2 75-2800	490x490	4.0
5SE0081	SKR2 75-3800	490x490	4.0
5SE0090	SKR2 75-5400	810x720	8.1

## SSE - Damper actuator

On/off type - 230V-50Hz, 1,5 W.

The actuator is not available separately. If requested, it is supplied assembled on the damper SKR1 / SKR2.



## GAT1 (Front) GAT2 (Lateral)

### Flexible connection

It allows a flexible connection between the base unit or its external modules and the air ducts, in order to prevent the transmission of vibrations to the latter. The dimensions coincide with the corresponding dampers SKR1 / SKR2.

**GAT 1:** Front / upper - lower (with plenum) flexible connection

**GAT 2:** Side flexible connection (with plenum)

GAT1		GAT2	
5SU0070	Front connection 450	5SU0076	Front connection 450
5SU0071	Front connection 800	5SU0077	Front connection 800
5SU0072	Front connection 1300	5SU0078	Front connection 1300
5SU0073	Front connection 1900	5SU0079	Front connection 1900
5SU0074	Front connection 2800	5SU0080	Front connection 2800
5SU0075	Front connection 3800	5SU0081	Front connection 3800
5SU0088	Front connection 5400	5SU0089	Front connection 5400

# REC PRO 75 ACCESSORIES

## BCC1 (Front) / BCC2 (Lateral) - Round adaptor for circular ducts

It allows the connection between the base unit or between its external modules and circular ducts.

Made of galvanized steel and provided with coupling plate (suitable for SKR1 / SKR2 and GAT1 / GAT2).

**BCC 1:** Front / upper - lower (with plenum) round adaptor for circular ducts - **BCC 2:** Side round adaptor for circular ducts (with plenum)

MODEL		75-450	75-800	75-1300	75-1900	75-2800	75-3800	75-5400
<b>Code BCC1</b>		<b>5B00070</b>	<b>5B00071</b>	<b>5B00072</b>	<b>5B00073</b>	<b>5B00074</b>	<b>5B00075</b>	<b>5B00069</b>
<b>Code BCC2</b>		<b>5B00076</b>	<b>5B00077</b>	<b>5B00078</b>	<b>5B00079</b>	<b>5B00080</b>	<b>5B00081</b>	<b>5B00068</b>
<b>Nominal Ø of the connection</b>	mm	250	315	315	400	500	500	596
<b>Connection thickness</b>	mm	100	100	100	100	100	100	100
<b>Nominal pressure loss</b>	Pa	7	7	16	10	9	16	12

## TPR-H / TPR-V / TPR-CH / TPR-CV - Roof cover

**TPR-H:** Horizontal unit - **TPR-V:** Vertical unit - **TPR-CH:** Horizontal unit with external module - **TPR-CV:** Vertical unit with external module.

The roof cover, in pre-painted steel, is necessary whenever the units are outdoor installed and could be exposed to bad weather.

### TPR-H

CODE	MODEL
<b>5TE0220</b>	TPR-H 450
<b>5TE0221</b>	TPR-H 800
<b>5TE0222</b>	TPR-H 1300
<b>5TE0223</b>	TPR-H 1900
<b>5TE0224</b>	TPR-H 2800
<b>5TE0225</b>	TPR-H 3800
<b>5TE0219</b>	TPR-H 5400

### TPR-CH

CODE	MODEL
<b>5TE0226</b>	TPR-CH 450
<b>5TE0227</b>	TPR-CH 800
<b>5TE0228</b>	TPR-CH 1300
<b>5TE0229</b>	TPR-CH 1900
<b>5TE0230</b>	TPR-CH 2800
<b>5TE0231</b>	TPR-CH 3800
<b>5TE0218</b>	TPR-CH 5400

### TPR-V

CODE	MODEL
<b>5TE0232</b>	TPR-V 450
<b>5TE0233</b>	TPR-V 800
<b>5TE0234</b>	TPR-V 1300
<b>5TE0235</b>	TPR-V 1900
<b>5TE0236</b>	TPR-V 2800
<b>5TE0237</b>	TPR-V 3800
<b>5TE0217</b>	TPR-V 5400

### TPR-CV

CODE	MODEL
<b>5TE0238</b>	TPR-CV 450
<b>5TE0239</b>	TPR-CV 800
<b>5TE0240</b>	TPR-CV 1300
<b>5TE0241</b>	TPR-CV 1900
<b>5TE0242</b>	TPR-CV 2800
<b>5TE0243</b>	TPR-CV 3800
<b>5TE0216</b>	TPR-CV 5400