

> ICA

Ventilatori centrifughi in materiale plastico

Centrifugal fans in plastic material

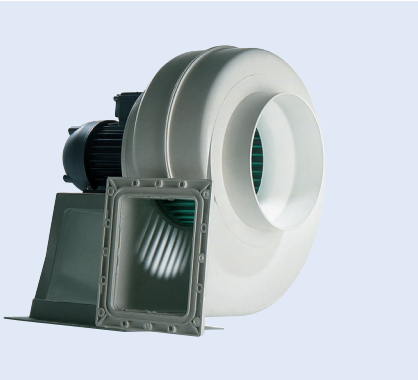

La serie non rientra nel campo di applicazione della Direttiva ErP 2009/125/CE e successivi regolamenti.

The series is not affected by the ErP Directive 2009/125/CE and further Regulations.

DESCRIZIONE GENERALE

La serie ICA è particolarmente adatta a convogliare fumi e vapori corrosivi (non abrasivi) o ad alto tasso di umidità con temperatura del fluido di max 50°C e con caratteristiche tecniche e meccaniche che permettono una durata nel tempo. Quando ha terminato il suo ciclo vitale, è facilmente smaltibile, grazie ai materiali riciclabili con cui è costruito.

Costruzione

- Coclea in polipropilene (PP).
- Girante a semplice aspirazione, realizzata in polipropilene (PP), con pale curve avanti e mozzo in alluminio protetto dal fluido trasportato.
- Sedia portamotore realizzata in lamiera d'acciaio e verniciata a polveri epossipoliestiriche.
- Costruzione antiscintilla.
- Motore asincrono trifase o monofase a norme internazionali IEC 60034, IEC 60072, EMC 2014/30/UE, LVD 2014/35/UE e marcato CE IP55, classe F, forma B3 o B5. Idoneo ad un servizio S1 (funzionamento continuo a carico costante).

ACCESSORI

- RD: Raccordo Quadro/Tondo

VERSIONI



ICA ATEX

Versione antideflagrante per ambienti a rischio di esplosione. Conforme alla Direttiva ATEX 2014/34/UE.

GENERAL DESCRIPTION

The ICA series is particularly designed for conveying smoke, corrosive vapours and smokes, also with high humidity level and with fluid temperature of max 50°C. ICA is a centrifugal forward curved fan with technical and mechanical characteristics that grant a long lasting operation, of low noise and high efficiency. When its lifetime is finished, is easy to dispose, being manufactured with recyclable materials.

CONSTRUCTION

- Volute in polypropylene (PP).
- Single inlet impeller, in Polypropylene (PP), with backward curved blades and aluminium hub (protected from the fluid).
- Motor support in epoxy painted steel sheet.
- Asynchronous three-phase or single-phase motors according to international standards IEC 60034, IEC 60072, EMC 2014/30/UE, LVD 2014/35/UE, CE marked, IP 55, class F, B3 or B5 shape. Suitable to a S1 service (continuous working to constant load).

ACCESSORIES

- RD: Square to Round connector

VERSIONS



ICA ATEX

Explosion proof version according to ATEX Directive 2014/34/UE.

ORIENTAMENTI Discharge angles

ICA

Rotazione Rotation RD						
Forma/Form	0	45°	90°	135°	270°	315°
Rotazione Rotation LG						

N.B.: Orientamento standard LG270°
Standard discharge angles LG 270°

Le prestazioni aerauliche sono rilevate in conformità alla norma EN ISO 5801/AMCA 210 con densità dell'aria standard avente peso specifico 1.2 Kg/m³. Alimentazione 230V/1Ph/50Hz o 400V/3Ph/50Hz.

Air performances measured according to EN ISO 5801 / AMCA 210 standard with air density with 1.2 Kg/m³ specific weight. Power supply 230V/1Ph/50Hz or 400V/3Ph/50Hz.

Lp: Livello di pressione sonora rilevato in condizioni di campo libero, propagazione sferica, categoria di misura C a norma EN ISO 13349, nel punto di massimo rendimento, alla distanza di 1,5 metri dal lato aspirazione e si presenta solo per fini comparativi.

Lp: Sound pressure level measured in free field conditions, propagation spherical, measurement category C in accordance with EN ISO 13349, at the point of maximum efficiency at a distance of 1.5 meters, inlet side (for comparative purposes only).

ICA 120

Cod.	Tipo Type	Modello Model	U	P	Pm (kW)	In (A)	IP/CL	LpA
1IA1202	ICA	120	M	2	0,12	1,20	55/F	68
1IA1203	ICA	120	T	4	0,12	0,38	55/F	68

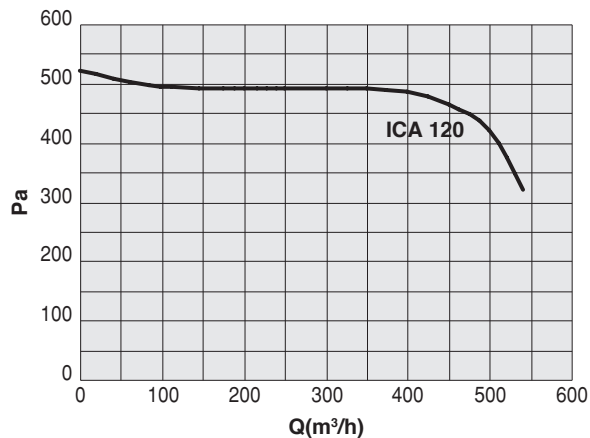

ICA 160

Cod.	Tipo Type	Modello Model	U	P	Pm (kW)	In (A)	IP/CL	LpA
1IA1608	ICA	160	M	4	0,18	1,70	55/F	57
1IA1609	ICA	160	T	4	0,18	0,65	55/F	57
1IA1610	ICA	160	T	2	1,10	2,55	55/F	57

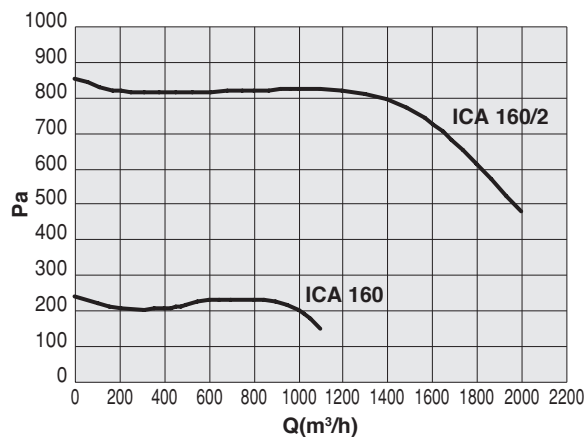

Le prestazioni aerauliche sono rilevate in conformità alla norma EN ISO 5801/AMCA 210 con densità dell'aria standard avente peso specifico 1.2 Kg/m³. Alimentazione 230V/1Ph/50Hz o 400V/3Ph/50Hz.

Air performances measured according to EN ISO 5801 / AMCA 210 standard with air density with 1.2 Kg/m³ specific weight. Power supply 230V/1Ph/50Hz or 400V/3Ph/50Hz.

Lp: Livello di pressione sonora rilevato in condizioni di campo libero, propagazione sferica, categoria di misura C a norma EN ISO 13349, nel punto di massimo rendimento, alla distanza di 1,5 metri dal lato aspirazione e si presenta solo per fini comparativi.

Lp: Sound pressure level measured in free field conditions, propagation spherical, measurement category C in accordance with EN ISO 13349, at the point of maximum efficiency at a distance of 1,5 meters, inlet side (for comparative purposes only).

ICA 200-250

Cod.	Tipo Type	Modello Model	U	P	Pm (kW)	In (A)	IP/CL	LpA
1IA2004	ICA	200	T	4	0,55	1,60	55/F	66
1IA2503	ICA	250	T	4	1,10	3,20	55/F	65

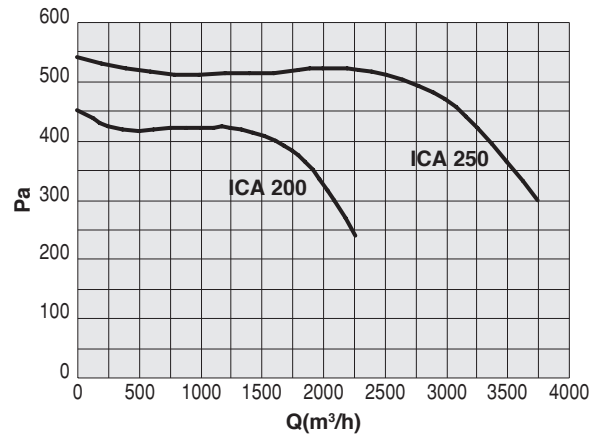

ICA 350

Cod.	Tipo Type	Modello Model	U	P	Pm (kW)	In (A)	IP/CL	LpA
1IA3503	ICA	350	T	4	3,00	7,50	55/F	70

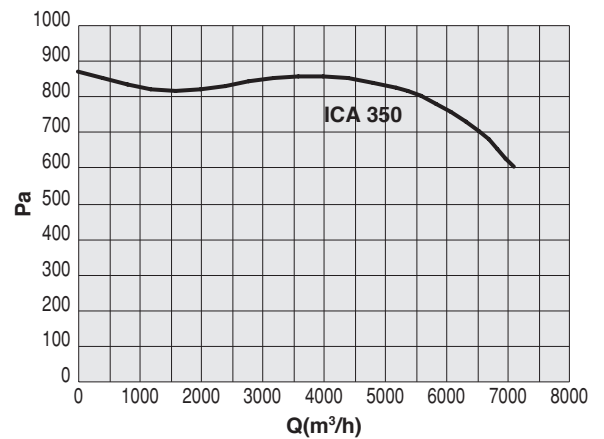

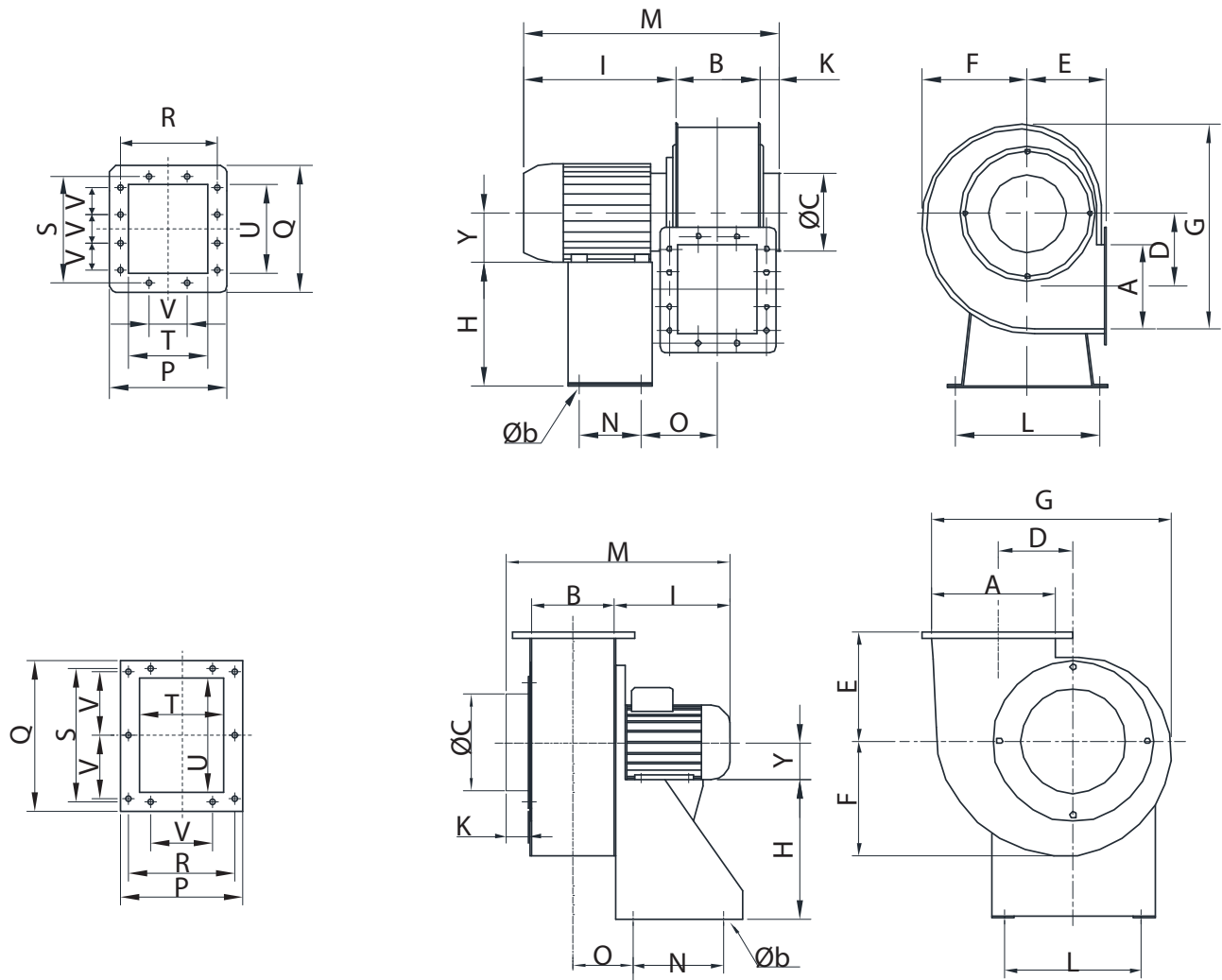

TIPO TYPE	A	B	ØC	D	E	F	G	H	Y	K	I	L	M	N	O	P	Q	R	S	T	U	V	øa	øb	n°fori øa	Kg*
120	90	90	125	103	109	133	270	130	55	28	179	175	297	130	80	135	135	110	110	85	85	-	7,5	10	4	4
160	165	135	200	148	148	201	297	200	63	48	207	215	390	170	95	180	180	164	194	130	160	85	7	10	6+2	8/13
200	205	165	250	185	180	240	503	250	80	45	245	255	455	175	125	228	266	200	240	160	200	80	7	10	8+2	15
250	245	205	315	222	218	293	590	310	90	65	282	234	552	175	155	265	306	241	282	195	240	100	9	12	6+4	29
350	290	235	355	259	268	356	699	320	100	60	315	285	610	200	170	305	356	275	326	225	280	100	9	12	8+4	48

Dimensioni in mm / *Dimensions in mm*
Pesi indicativi / *Indicative weights*

RACCORDO QUADRO / TONDO - *SQUARE TO ROUND CONNECTOR*

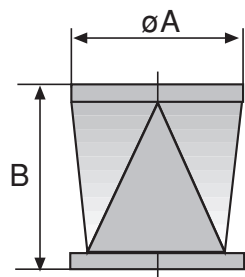

Cod.	DESCRIZIONE	$\varnothing A$	B
5RD1015	RACCORDO ICA 120	125	95
5RD1021	RACCORDO ICA 160	200	168
5RD1025	RACCORDO ICA 200	250	160
5RD1027	RACCORDO ICA 250	315	170
5RD1026	RACCORDO ICA 350	315	210
5RD1028	RACCORDO ICA 350	355	210

Dimensioni in mm / *Dimensions in mm*