

> DIC-ATX / DIC-ATX INOX

Ventilatori centrifughi pale avanti

Forward curved blade centrifugal fans

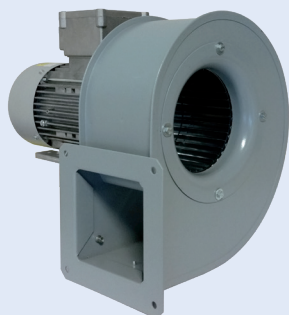

DIC-ATX



Certificato / *Certificate*
IMQ 10 ATEX 018 X

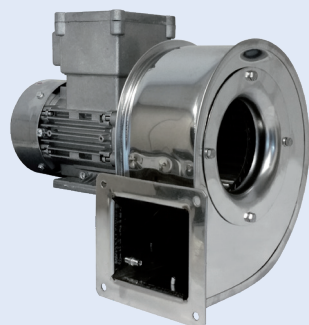

DIC INOX-ATX



Certificato / *Certificate*
IMQ 10 ATEX 018 X



Adatto per aria corrosiva / acida.
Suitable for corrosive / acid air.

DESCRIZIONE GENERALE

I ventilatori centrifughi della serie DIC-ATX e DIC-ATX INOX sono costruiti e certificati in conformità alla Direttiva ATEX 2014/34/UE ed il loro impiego è previsto con aria pulita e fumi non polverosi con temperatura da -20°C a +40°C. Sono adatti all'installazione in zona 1/21, cioè in aree o ambienti dove sia necessario garantire un elevato fattore di sicurezza contro le esplosioni, dovuti a gas (IIG) o polveri infiammabili (IID). La loro costruzione è certificata da IMQ secondo la EN 14986/2017 (Certificato IMQ 10 ATEX 018 X). Trovano il loro impiego in tutte quelle applicazioni industriali dove siano richiesti piccoli volumi d'aria con alte pressioni. La serie è costituita da modelli con diametro girante da 100 a 180 mm. Il motore è direttamente accoppiato alla girante del tipo pale avanti. La cassa è facilmente orientabile, anche in sito, ogni 45°, compresi gli angoli 180° e 225°. DIC-ATEX INOX è realizzato in acciaio Inox AISI 304 ed è adatto per convogliare aria corrosiva e/o acida.

COSTRUZIONE

- Cassa a spirale realizzata in lamiera d'acciaio protetta contro gli agenti atmosferici con vernici a polveri epossipoliestiriche oppure in acciaio inossidabile AISI304.
- Girante a semplice aspirazione con pale curve in avanti (sirocco), a spessore costante, realizzata in lamiera zincata oppure in acciaio inossidabile AISI304.
- Boccaglio in lamiera verniciata o inox su modelli con esecuzione IIB. Boccaglio in ottone su modelli con esecuzione IIB+H₂.
- Esecuzione 5, (accoppiamento diretto con girante a sbalzo su motore flangiato).
- Motore separato dal flusso di aria convogliata.
- Orientamento standard LG 270°.
- Raccordo in aspirazione fornito in dotazione (non montato)

ACCESSORI

- Sedia portamotore lamiera / inox.
- Rete di protezione per bocca aspirante e premente realizzata a norma uni 12499 e protetta contro gli agenti atmosferici.

MOTORIZZAZIONI

- DIC-ATX e DIC-ATX INOX: motore asincrono trifase o monofase a norme internazionali IEC 60034, IEC 60072, IEC 60079 e/o IEC 61241, EMC 2004/108/CE, LVD 2006/95/CE, con certificati ATEX per atmosfere esplosive Categoria G gruppo II classe termica T4 protezione Exd e marcatura CE, IP 55, classe F, forma B35. Idonei ad un servizio S1 (funzionamento continuo a carico costante).

A RICHIESTA

- Versioni con temperature d'esercizio diverse.
- Versioni con motori per atmosfere diverse.
- Versioni con motori idonei alla regolazione della velocità.

GENERAL DESCRIPTION

The centrifugal fans of the DIC-ATX and DIC-ATX INOX series are designed and constructed to operate in potentially explosive environments, according to the ATEX Directive 2014/34/EU. They are suitable to convey clean and non-dusty air in the temperature range of -20°C +40°C. They are suitable for installation in zone 1/21, that are areas where it is necessary to guarantee high security against explosions and fires due to the presence of flammable gas (IIG) or dusts (IID). These fans are certified by IMQ according to ATEX Directive 94/9/CE and to EN 14986/2017 (Certificate IMQ 10 ATEX 018 X). They are suitable for all the industrial applications where small air volumes and high pressures are required. The series consists of different models with impeller diameter from 100 to 180 mm. The motor is directly fitted to the forward curved impeller. The casing is easily adjustable, also on site, to the required discharge angle every 45°, including 180° and 225°. DIC-ATX INOX is made in stainless steel AISI304 and is suitable for conveying corrosive / acid air.

CONSTRUCTION

- Volute casing in steel sheet, protected against atmospheric agents by epoxy paint or in stainless steel AISI304 sheet.
- Single inlet, single gauge, forward curved impeller (sirocco type), in galvanized steel sheet or in stainless steel AISI304.
- Steel sheet inlet with epoxy finish or inox inlet on models IIB. Brass inlet on models with execution IIB+H₂.
- Execution 5 (with impeller directly coupled to flanged motor).
- Motor separated from the conveyed airflow.
- Standard orientation LG270°.
- Inlet connector supplied (disassembled)

ACCESSORIES









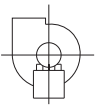

- Motor support in steel or steel sheet.
- Inlet and outlet protection guard manufactured according to UNI 12499 norm and protected against the atmospheric agents.

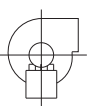
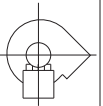
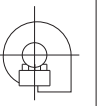
MOTOR

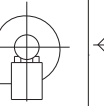
- DIC-ATX and DIC-ATX INOX asynchronous three-phase motors or single-phase according to international standards IEC 60034, IEC 60072, IEC 60079 and/or IEC61241, EMC 2004/108/CE, LVD 2006/95/CE, with ATEX certification for explosive atmospheres category G group II thermal class T4 protection Exd, CE marked, IP55, class F, B35 shape. Suitable to S1 service (continuous working at constant load).

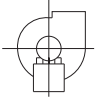
UPON REQUEST

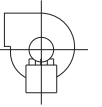
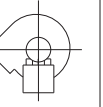
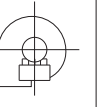
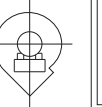
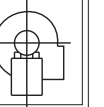
- Versions with different temperature ranges.
- Versions with motors for different atmospheres.
- Versions with motors suitable for speed regulation.

Rotazione <i>Rotation</i> RD								
Forma/Form	0°	45°	90°	135°	180°	225°	270°	315°
Rotazione <i>Rotation</i> LG								

N.B.: Orientamento standard LG 270° - Orientamenti LG 45°, 135°, 225° e 315° non disponibili per DIC 100 e 120.
Standard discharge angles LG 270° - Discharge angles LG 45°, 135°, 225° e 315° not available on DIC 100 and 120.

PRESTAZIONI *Performance*

DIC-ATX / DIC-ATEX INOX

Le prestazioni aeruliche sono rilevate in conformità alla norma EN ISO 5801/AMCA 210 con densità dell'aria standard avente peso specifico 1,2 Kg/m³.
 Alimentazione 230V/1Ph/50Hz o 400V/3Ph/50Hz.

*Air performances measured according to EN ISO 5801 / AMCA 210 standard with air density with 1.2 kg/m³ specific weight.
 Power supply 230V/1Ph/50Hz or 400V/3Ph/50Hz.*

Lp: Livello di pressione sonora rilevato in condizioni di campo libero, propagazione sferica, categoria di misura D a norma EN ISO 13349, nel punto di massimo rendimento, alla distanza di 1,5 metri irradiato e si presenta solo per fini comparativi.

Lp: Sound pressure level measured in free field conditions, propagation spherical, measurement category D in accordance with EN ISO 13349, at the point of maximum efficiency, at a distance of 1,5 meters (for comparative purposes only).

Lw: Livello di potenza sonora ottenuto secondo norma ISO 3746. Tolleranza +/- 3 dB(A).

Lw: Sound power level obtained in accordance with EN ISO 3746. Tolerance +/- 3 dB(A).

DIC-ATX / DIC-ATEX INOX 100

Cod.	Tipo Type	Modello Model	U	P	Pm (kW)	In (A)	IP/CL	Mot. (Gr)
1XD1000 1XD1003	DIC-ATX DIC-ATEX INOX	100	M	2	0,06	0,6	55/F	56
1XD1001 1XD1002	DIC-ATX DIC-ATEX INOX	100	T	2	0,09	0,26	55/F	56

Limiti d'impiego - *Operational limit*

Tipo Type	Modello Model	Q max (m ³ /h)	Pt min (Pa)	C max (m/s)	S (m ²)	Pd ² (kgm ²)
DIC-ATX DIC-ATEX INOX	100/2	430	156	18,70	0,006384	0,0016

Livelli sonori - *Sound levels / dB(A)*

[Hz]	63	125	250	500	1000	2000	4000	8000	TOT
DIC 100/2 Lw	45	57	62	66	71	64	56	46	73
DIC 100/2 Lp	34	46	51	55	60	53	45	35	62

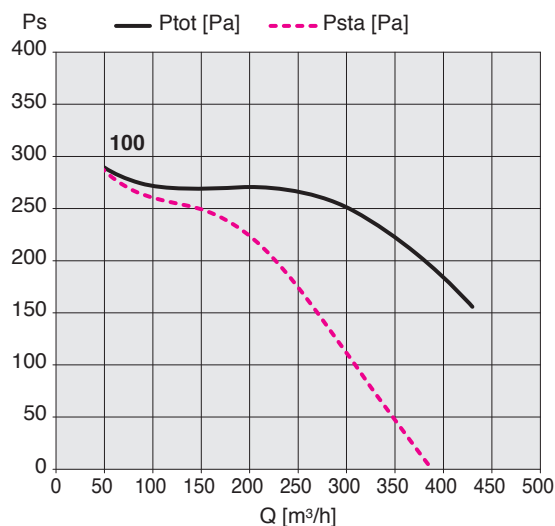

DIC-ATX / DIC-ATEX INOX 120

Cod.	Tipo Type	Modello Model	U	P	Pm (kW)	In (A)	IP/CL	Mot. (Gr)
1XD1200 1XD1216	DIC-ATX DIC-ATEX INOX	120	M	2	0,25	1,91	55/F	63
1XD1201 1XD1202	DIC-ATX DIC-ATEX INOX	120	T	2	0,25	0,80	55/F	63

Limiti d'impiego - *Operational limit*

Tipo Type	Modello Model	Q max (m ³ /h)	Pt min (Pa)	C max (m/s)	S (m ²)	Pd ² (kgm ²)
DIC-ATX DIC-ATEX INOX	120/2	825	325	22,01	0,010404	0,0036

Livelli sonori - *Sound levels / dB(A)*

[Hz]	63	125	250	500	1000	2000	4000	8000	TOT
DIC 120/2 Lw	44	54	68	73	69	74	69	65	78
DIC 120/2 Lp	33	43	57	62	58	63	58	54	67

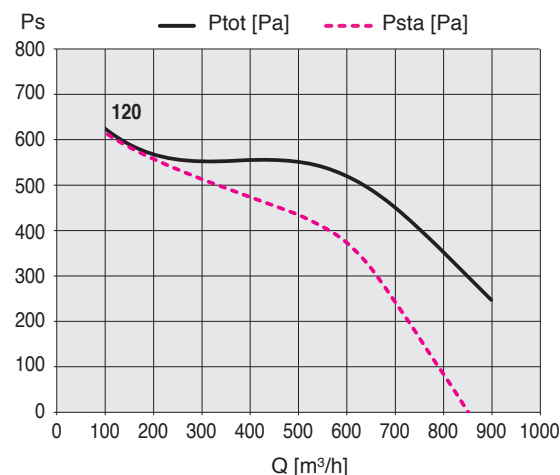

Le prestazioni aerauliche sono rilevate in conformità alla norma EN ISO 5801/AMCA 210 con densità dell'aria standard avente peso specifico 1,2 kg/m³. Alimentazione 230V/1Ph/50Hz o 400V/3Ph/50Hz.

Air performances measured according to EN ISO 5801 / AMCA 210 standard with air density with 1.2 kg/m³ specific weight. Power supply 230V/1Ph/50Hz or 400V/3Ph/50Hz.

Lp: Livello di pressione sonora rilevato in condizioni di campo libero, propagazione sferica, categoria di misura D a norma EN ISO 13349, nel punto di massimo rendimento, alla distanza di 1,5 metri (irradiato e si presenta solo per fini comparativi).

Lp: Sound pressure level measured in free field conditions, propagation spherical, measurement category D in accordance with EN ISO 13349, at the point of maximum efficiency, at a distance of 1,5 meters (for comparative purposes only).

Lw: Livello di potenza sonora ottenuto secondo norma ISO 3746. Tolleranza +/- 3 dB(A).

Lw: Sound power level obtained in accordance with EN ISO 3746. Tolerance +/- 3 dB(A).

DIC-ATX / DIC-ATX INOX 140

Cod.	Tipo Type	Modello Model	U	P	Pm (kW)	In (A)	IP/CL	Mot. (Gr)
1XD1400 A RICHIESTA	DIC-ATX DIC-ATX INOX	140	M	2	0,37	2,71	55/F	71
1XD1401 1XD1402	DIC-ATX DIC-ATX INOX	140	T	2	0,37	1,00	55/F	71

Limiti d'impiego - Operational limit

Tipo Type	Modello Model	Q max (m ³ /h)	Pt min (Pa)	C max (m/s)	S (m ²)	Pd ² (kgm ²)
DIC-ATX DIC-ATX INOX	140/2	1260	530	25,14	0,013924	0,0064

Livelli sonori - Sound levels / dB(A)

[Hz]	63	125	250	500	1000	2000	4000	8000	TOT
DIC 140/2 Lw	52	60	75	77	77	78	76	70	84
DIC 140/2 Lp	41	49	64	66	66	67	65	59	73

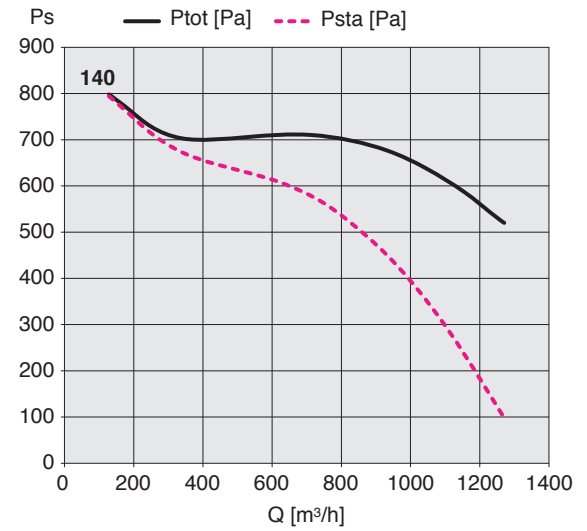

DIC-ATX / DIC-ATX INOX 160

Cod.	Tipo Type	Modello Model	U	P	Pm (kW)	In (A)	IP/CL	Mot. (Gr)
1XD1601 1XD1602	DIC-ATX DIC-ATX INOX	160	T	2	0,75	1,80	55/F	80

Limiti d'impiego - Operational limit

Tipo Type	Modello Model	Q max (m ³ /h)	Pt min (Pa)	C max (m/s)	S (m ²)	Pd ² (kgm ²)
DIC-ATX DIC-ATX INOX	160/2	2300	798	35,01	0,018225	0,0104

Livelli sonori - Sound levels / dB(A)

[Hz]	63	125	250	500	1000	2000	4000	8000	TOT
DIC 160/2 Lw	53	64	79	81	82	83	81	75	89
DIC 160/2 Lp	42	53	68	70	71	72	70	64	78

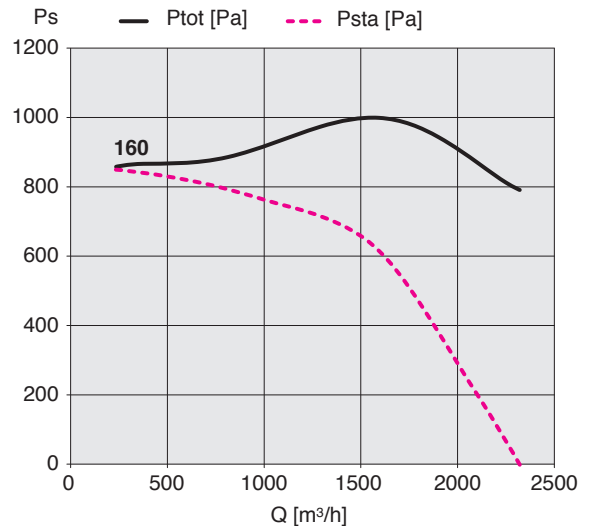

DIC-ATX / DIC-ATX INOX 180

Cod.	Tipo Type	Modello Model	U	P	Pm (kW)	In (A)	IP/CL	Mot. (Gr)
1XD1800 1XD1801	DIC-ATX DIC-ATX INOX	180	T	2	1,10	2,40	55/F	80

Limiti d'impiego - Operational limit

Tipo Type	Modello Model	Q max (m ³ /h)	Pt min (Pa)	C max (m/s)	S (m ²)	Pd ² (kgm ²)
DIC	180/2	2800	655	35,47	0,021904	0,02

Livelli sonori - Sound levels / dB(A)

[Hz]	63	125	250	500	1000	2000	4000	8000	TOT
DIC 180/2 Lw	61	71	83	85	87	86	84	78	92
DIC 180/2 Lp	50	60	72	74	76	75	73	67	81

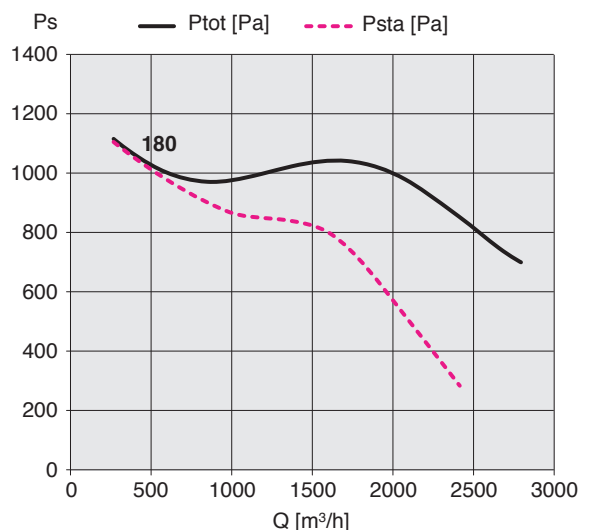

Lp: livello di pressione sonora rilevato a 1,5 m.
Lp: sound pressure level measured at 1,5 m.

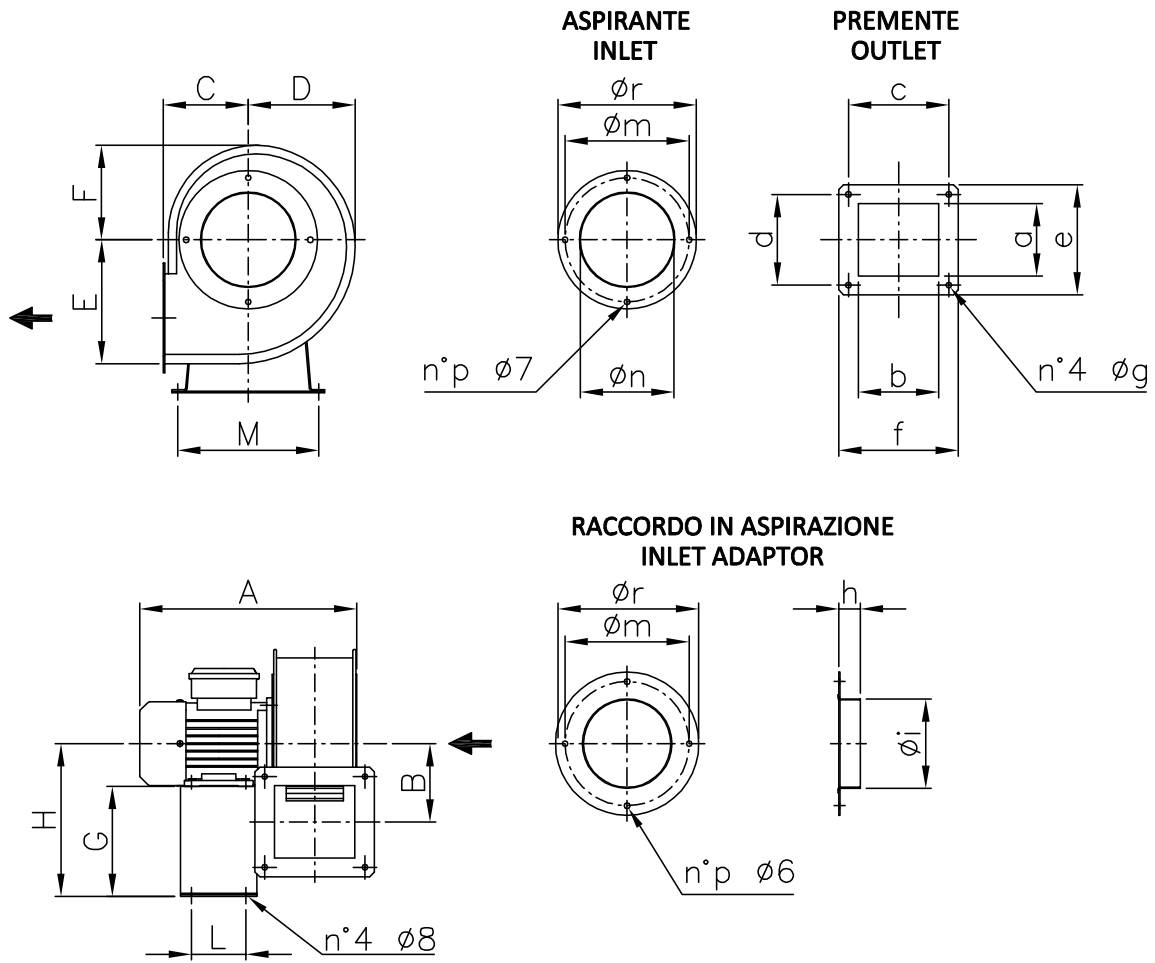

N.B. Raccordo in aspirazione fornito non montato.
N.B. Inlet adaptor supplied, not assembled.

TIPO - TYPE	A	B	C	D	E	F	G	H	L	M	kg
DIC-ATX / DIC-ATX INOX 100	220	82	86	112	130	99	120	176	71	140	4
DIC-ATX / DIC-ATX INOX 120	300	97	109	137	156	116	160	223	80	185	7
DIC-ATX / DIC-ATX INOX 140	350	115	126	158	184	136	152	223	90	185	10
DIC-ATX / DIC-ATX INOX 160	390	132	143	175	207	148	180	260	100	230	17
DIC-ATX / DIC-ATX INOX 180	400	140	156	200	227	171	180	260	100	230	20

TIPO - TYPE	a	b	c	d	e	f	g	h	i	m	n	p	r
DIC-ATX / DIC-ATX INOX 100	76	84	105	95	115	125	6	20	100	130	90	4	145
DIC-ATX / DIC-ATX INOX 120	102	102	125	125	150	150	7	20	125	160	115	4	178
DIC-ATX / DIC-ATX INOX 140	118	118	148	148	175	175	8	30	125	180	135	4	195
DIC-ATX / DIC-ATX INOX 160	135	135	165	165	195	195	8	40	160	222	155	8	240
DIC-ATX / DIC-ATX INOX 180	148	148	180	180	210	210	8	40	160	222	170	8	240

NB: accessori non contemplati nel **Certificato di Esame del Tipo**. Contattare il servizio tecnico-commerciale per esigenze costruttive diverse.
NB: accessories not included in the **Type Examination Certificate**. Please contact us for any different construction requirements.

SEDIA PORTAMOTORE / MOTOR SUPPORT

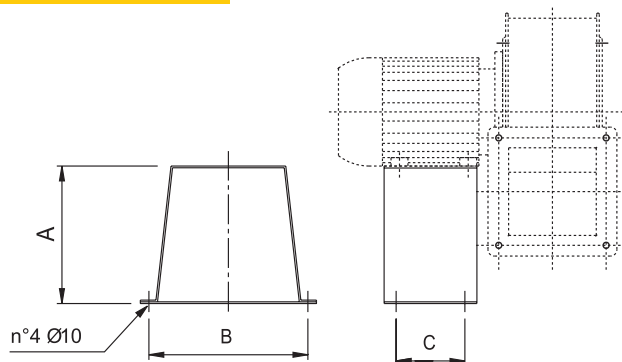

Cod.*	TIPO / TYPE	A	B	C	Kg
1SE6007	100	120	140	71	0,5
1SE6005	120	160	185	80	1,2
1SE6017	140	152	185	90	1,3
1SE6006	160 - 180 grandezza motore 80 / motor size 80	180	230	100	1,7

Dimensioni in mm / Dimensions in mm - Pesì indicativi / Indicative weights

* Codici modelli DIC-ATX. Codici per modelli ATX INOX a richiesta.
 Item codes relative to models DIC-ATX. Item codes for models DIC-ATX INOX available upon request.

RETE BOCCA PREMENTE / OUTLET GUARD

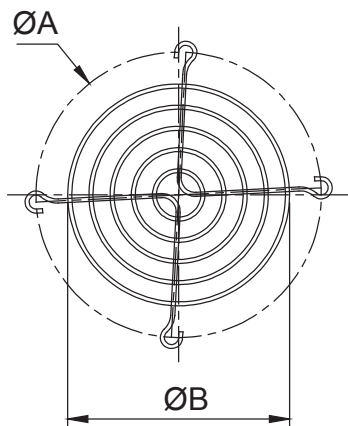

Cod. DIC-ATX	Cod. DIC-ATEX INOX	TIPO / TYPE	ØA	ØB	Kg
5RE0109	5RE1109	Rete / Guard - 100	142	110	0,06
5RE0111	5RE1111	Rete / Guard - 120	177	131	0,12
5RE0113	5RE1113	Rete / Guard - 140	209	152	0,13
5RE0115	5RE1115	Rete / Guard - 160	233	194	0,15
5RE0117	5RE1117	Rete / Guard - 180	255	194	0,2

Dimensioni in mm / Dimensions in mm

RETE BOCCA ASPIRANTE / INLET GUARD

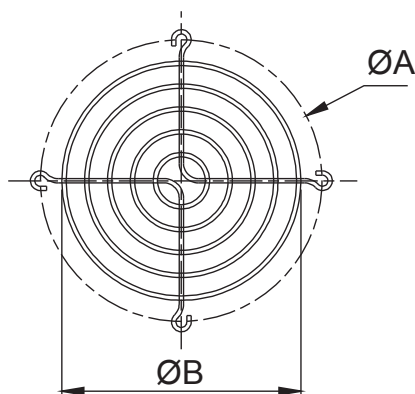

Cod. DIC-ATX	Cod. DIC-ATEX INOX	TIPO / TYPE	ØA	ØB	Kg
5RE1500	5RE1511	Rete / Guard - 100	130	110	0,06
5RE1501	5RE1512	Rete / Guard - 120	160	131	0,12
5RE1502	5RE1513	Rete / Guard - 140	180	152	0,12
5RE1503	5RE1509	Rete / Guard - 160-180	222	194	0,15

Dimensioni in mm / Dimensions in mm